

# **2015-18 CommanderVP Flowmeter Wiring Manual**

Revised January 1, 2018

# **Items Covered In This Manual:**

**Page 2: Netafim/Dwyer Mechanical Flow Meter Wiring**

**Page 3: Netafim Octave Flow Meter Wiring**

**Page 4: GF Signet “Open Collector ” Flow Meter Wiring**

**Page 5-9: GF Signet 8550 Flow Transmitter Wiring**

**Page 10: McCrometer Mechanical Flow Meter Wiring**

**Page 11-12: Seametrics AG2000, AG3000/Valley Flow Meter**

**Page 13-14: Endress Hauser Promag P 50/53 Flow Meters**

**Page 15-16: Siemens MAG5000 Flow Meters**

**Page 17-19: Seametrics PE102/FT520 Flow Meter Wiring**

**Page 20-22: GF Signet 9900 Flow Transmitter Wiring**

**Page 23-24: GF Signet 2551 Mag Meter Wiring**

**Page 25: McCrometer FlowCom Flow Meter Wiring**

**Page 26-27: McCrometer McMag 3000/EA-618 Flow Meters**

**Page 28-29: Siemens Sitrans FM MAG 8000 Wiring**

**Page 30-32: Greyline AVFM 5.0 Flow Meter Wiring**

**Page 33-34: Senninger Flow Wise SC-3 Flow Meter Wiring**

**Page 35-36: Banjo MFM 300DC Flow Meter Wiring**

**Page 37-38: Seametrics FT415 Flow Meter Wiring**

**Page 39-41: Sparling Tiger Mag Flow Meter Wiring**

**Page 42-43: Sparling FT194 Flow Meter Wiring**

**Page 44: Generic Flow Meter Wiring**

# Wire Connections for the Netafim/Dwyer Mechanical Flow Meter

(two wire magnetic reed-switch style)

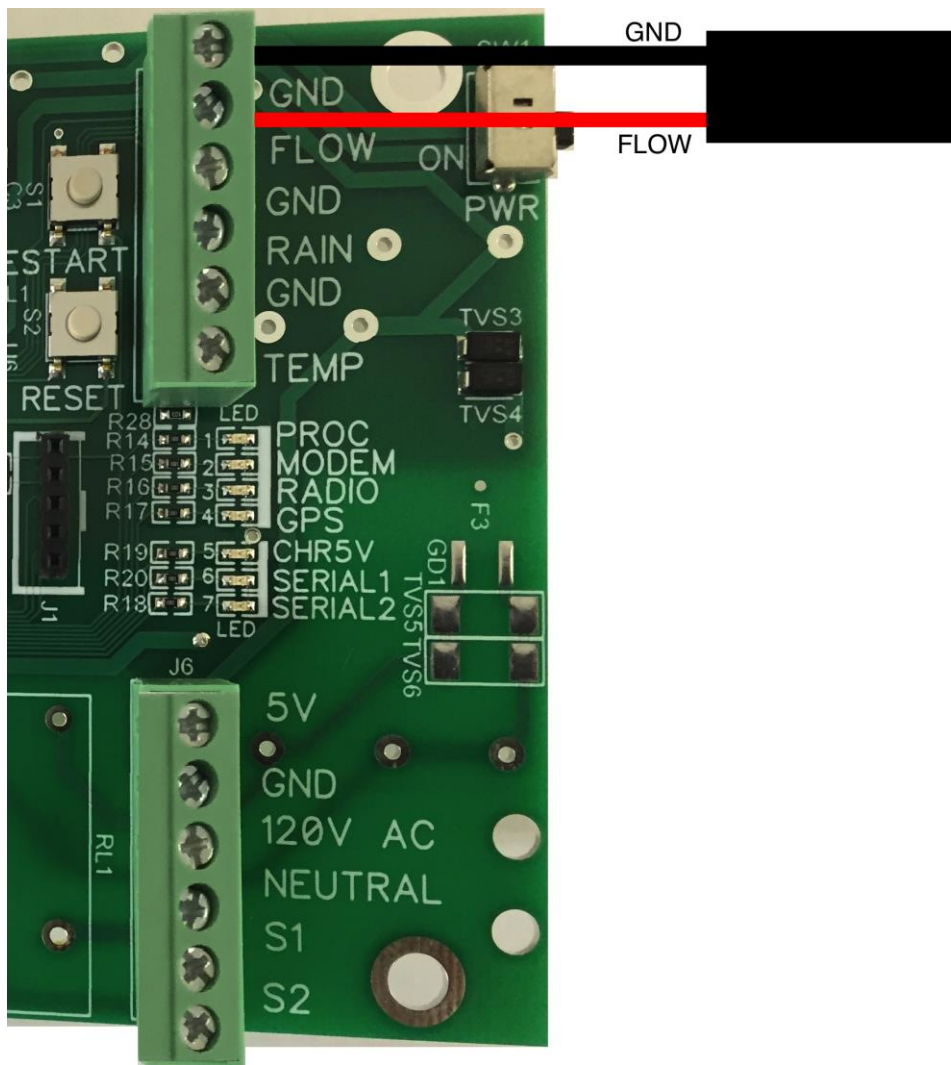

1. Install the Black Wire from the Netafim/Dwyer Flow Meter into any terminal marked **GND** as shown in the picture above.
2. Install the Red Wire from the Netafim/Dwyer Flow Meter into the terminal marked **FLOW** as shown in the picture above.

# Wire Connections for the Netafim Octave Flow Meter (with pulse output module)

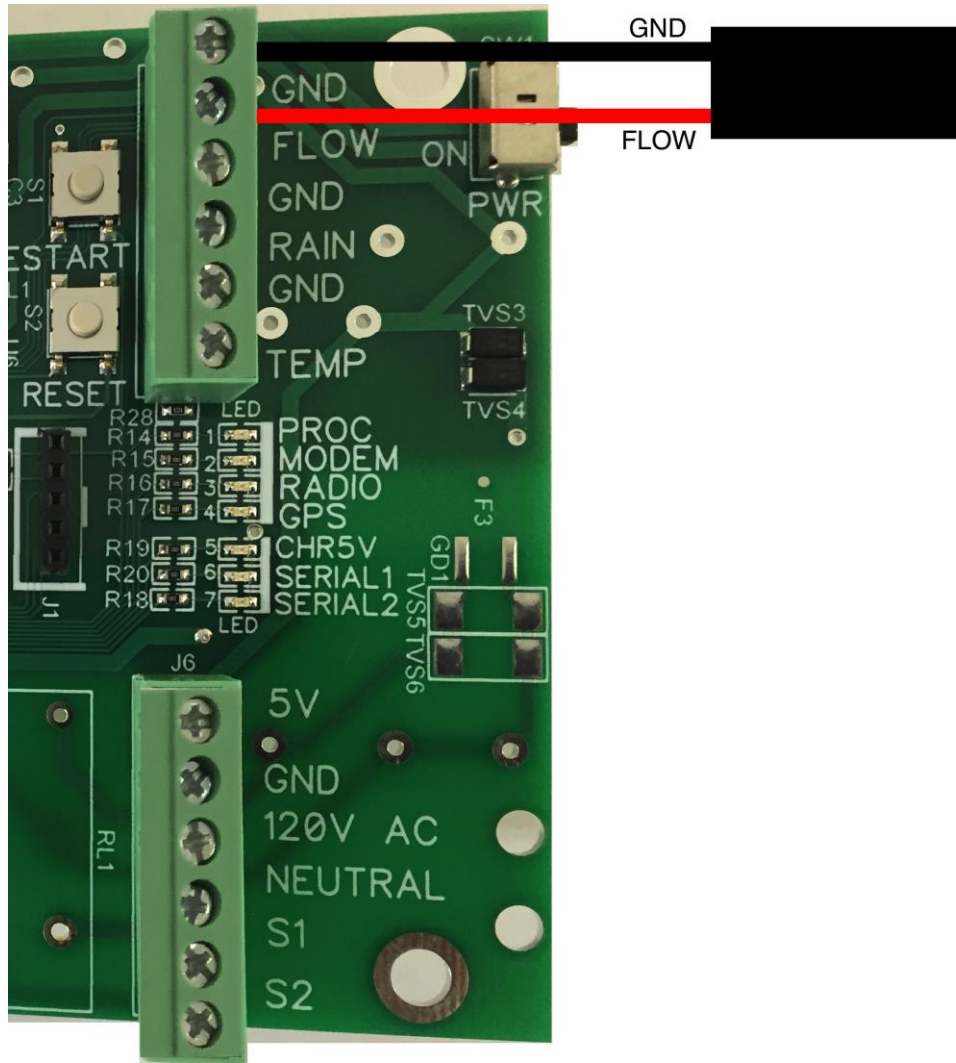

1. Install the Black Wire from the Netafim Flow Meter into any terminal marked **GND** as shown in the picture above.
2. Install the Red Wire from the Netafim Flow Meter into the terminal marked **FLOW** as shown in the picture above.
3. Cut off and/or tape off the Green Wire from the Netafim Flow meter so that it cannot touch anything.
4. The label on the inside of the Netafim Flow Meter lid will show how many gallons per pulse that output1 (the red wire) is programmed to do. You will need that info when configuring this unit on Wagnet.

# Wire Connections for the GF Signet/Senniger “Open Collector –Type” Flow Meters

Note: The flow meter must be an “Open Collector” type output.  
( For example, models:Ag Rotor 4-3000-5, 2507 mini 198-801-732, 2000 micro 198-822-000 flow meters)

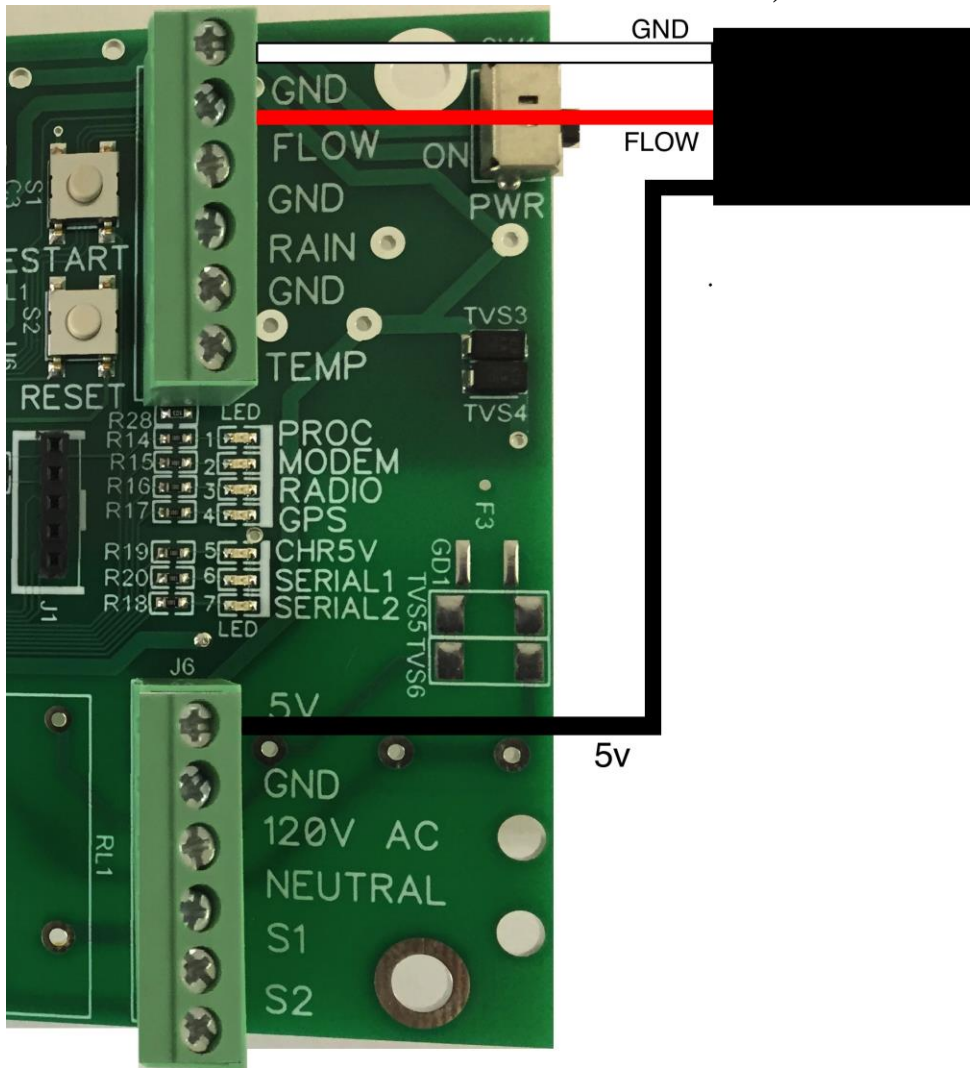

1. Install the Black Wire from the GF Signet Flow Meter into the screw terminal marked **5v** as shown in the picture above. (add it in with the 5v wire that is already in that terminal)
2. Install the White/Bare Wire from the GF Signet Flow Meter into any terminal marked **GND** as shown in the picture above.
3. Install the Red Wire from the GF Signet Flow Meter into the terminal marked **FLOW** as shown in the picture above.

# Wire Connections for the GF Signet/Senniger 8550 Flow Transmitter

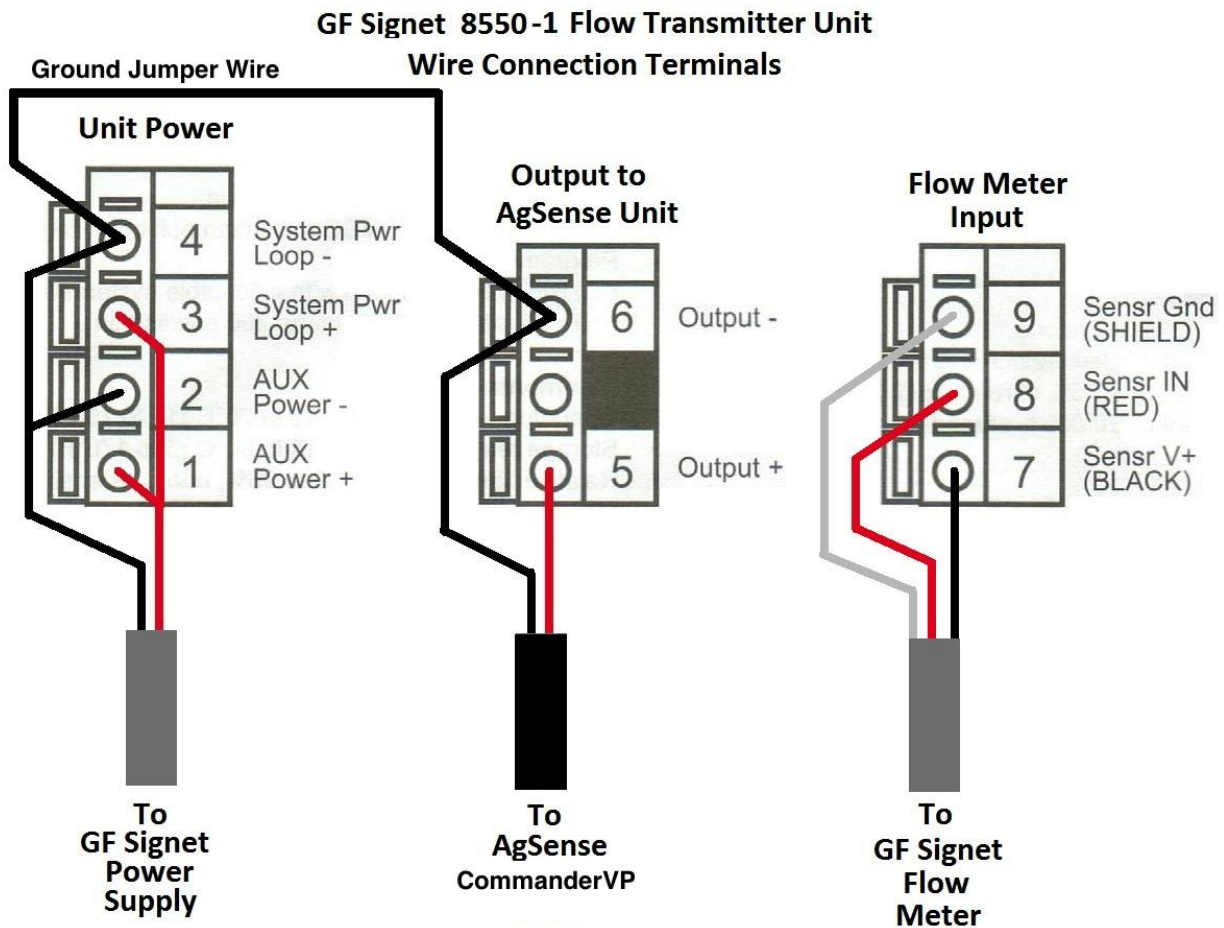

Power supply Ground and CommanderVP ground must be connected together with a jumper wire as shown

1. Install the Power Supply, and Flow Meter wires into the GF Signet 8550 Unit as shown above.
2. Install a Red wire into terminal 5 (output+) of the 8550 Unit as shown above. This wire will connect to the AgSense unit in the steps below.
3. Install a Black wire into terminal 6 (output-) of the 8550 Unit as shown above. This wire will connect to the AgSense unit in the steps on the next page.

## Wire Connections for the GF Signet/Senniger 8550 Flow Transmitter Cont.

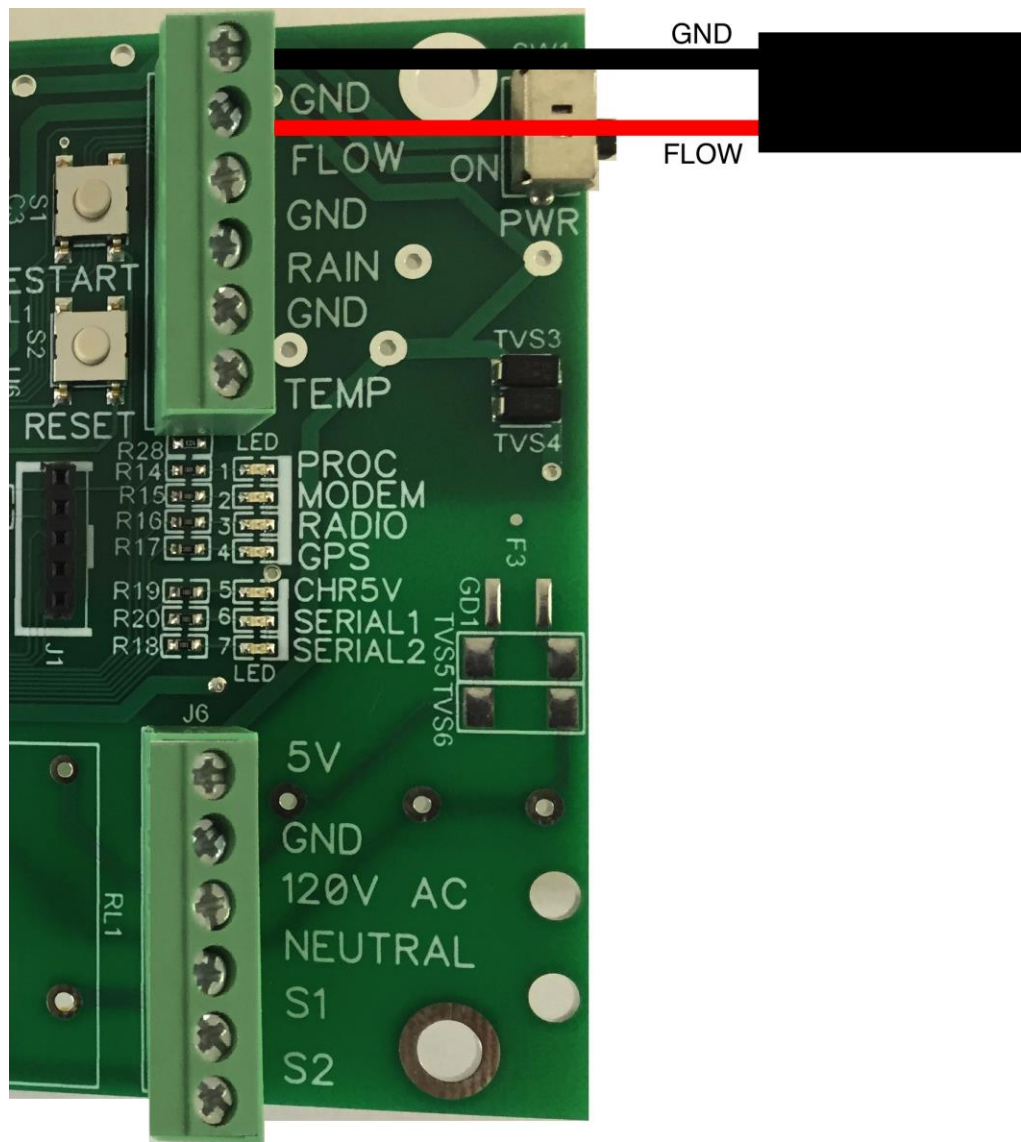

1. Install the Black Wire from the GF Signet 8550 Flow Transmitter into any terminal marked **GND** as shown in the picture above.
2. Install the Red Wire from the GF Signet 8550 Flow Transmitter into the terminal marked **FLOW** as shown in the picture above.
3. Setting up the 8550 Flow Transmitter “calibrate” and “options” menus – use the charts below to correctly set up the menus in the 8550 Flow Transmitter – you must do this for the AgSense unit to work properly.

**EDITING THE CALIBRATE AND OPTIONS MENUS - THIS MUST BE DONE  
WHEN CONNECTING TO AGSENSE UNIT**

**Step 1. Press and hold ENTER key:**

- 2 seconds to select the CALIBRATE menu
- 5 seconds to select the OPTIONS menu.

**Step 2. The Key Code is UP-UP-UP-DOWN keys in sequence.**

- After entering the Key Code, the display will show the first item in the selected menu.

**Step 3. Scroll menu with UP or DOWN arrow keys.**

**Step 4. Press RIGHT ARROW key to select menu item to be edited.**

- The first display element will begin flashing.

**Step 5. Press UP or DOWN keys to edit the flashing element.**

- RIGHT ARROW key advances the flashing element.

**Step 6. Press ENTER key to save the new setting and return to Step 3.**



## Calibrate Menu

Display	Description
Flow Units: GPM >	<b>Keep this set to "GPM" (gallons per minute)</b>
Flow K-Factor: 1.707 (example only) >	This setting tells the transmitter how to convert the input frequency from the flow sensor into a flow rate. The K-factor is unique to the sensor model and to the pipe size and schedule. <b>Refer to the data chart in the GF Signet Flow Sensor Manual for the correct value</b>
Total Units: Gallons >	This setting identifies the Totalizer units. It has no effect on any calculation. It serves as a label only. Each character can be any alpha or numeric selection, upper or lower case.
Total K-Factor 1.707 (example only) >	This setting tells the transmitter how to convert the input frequency from the flow sensor into a volumetric total. <b>Refer to the data chart in the GF Signet Flow Sensor Manual for the correct value</b> <b>This needs to be the same as the "Flow K-Factor" above.</b>
Loop Range: GPM 000.00 → 100.00 >	<b>Not Used when connecting to AgSense Unit</b> <b>Leave this set to factory defaults</b>
Output Mode: Pulse >	<b>This must be set to "Pulse" when connecting to AgSense Unit</b>
Output Setpnt: 10.0 GPM >	<b>Not Used when connecting to AgSense Unit</b> <b>Leave this set to factory defaults</b>
Output Hys: 5.0 GPM >	<b>Not Used when connecting to AgSense Unit</b> <b>Leave this set to factory defaults</b>
Output Volume: 100.00 Gallons >	In Pulse mode, the Open collector output will generate one pulse when this volume of flow passes the sensor. <b>This must be set to "100.00" when connecting to AgSense Unit</b>
Output PlsWdth: 0.1 Seconds >	In Pulse mode, this setting defines the duration of the Open Collector output pulse. <b>This must be set to "0.1 Seconds" when connecting to AgSense Unit.</b>
Output Freq.: Divide by 1 >	<b>Not Used when connecting to AgSense Unit</b> <b>Leave this set to factory defaults</b>
Last CAL: 4-20-06	Use this "note pad" to record important dates, such as annual recertification or scheduled maintenance.

## Options Menu

Display	Description
Contrast: 3 >	Adjust the LCD contrast for best viewing. A setting of 1 is lower contrast, 5 is higher. Select lower contrast if the display is in warmer ambient surroundings.
Flow Decimal ***** >	Set the decimal to the best resolution for your application. The display will automatically scale up to this restriction. Select *****., *****, ***, **, * or *.****
Total Decimal *****.** >	Set the totalizer decimal to the best resolution for your application. Select *****., ******, or *****.**
Averaging: Off >	OFF provides the quickest output response to changes in flow. <b>This setting needs to be "OFF" when connecting to AgSense Unit</b>
Sensitivity 0 >	<b>Not Used when connecting to AgSense Unit</b> <b>Leave this set to factory defaults</b>
Total Reset: Lock Off >	Lock Off : No key code required to reset the resettable totalizer. Lock On : The Key Code must be entered to reset the resettable totalizer.
Loop Adjust: 4.00 mA >	<b>Not Used when connecting to AgSense Unit</b> <b>Leave this set to factory defaults</b>
Loop Adjust: 20.00 mA >	
Output Active: High >	<b>This setting needs to be "High" when connecting to AgSense Unit</b>
Test Loop: >	<b>Not Used when connecting to AgSense Unit</b> <b>Leave this set to factory defaults</b>
Test Output: >	<b>Not Used when connecting to AgSense Unit</b> <b>Leave this set to factory defaults</b>

## **Wire Connections for the McCrometer Mechanical Flow Meter with EA-631-xxx module**

**The CommanderVP does not support the  
McCrometer EA-631 Pulse Module – The new part  
number for mechanical McCrometer flow meters is  
EA-618-02. Please use the EA-618-02 Pulse Module  
for mechanical flow meter installations.**

**Please see page 26 for EA-618-02 Wiring.**

# Wire Connections for the Seametrics AG2000, AG3000/Valley Flow Meter

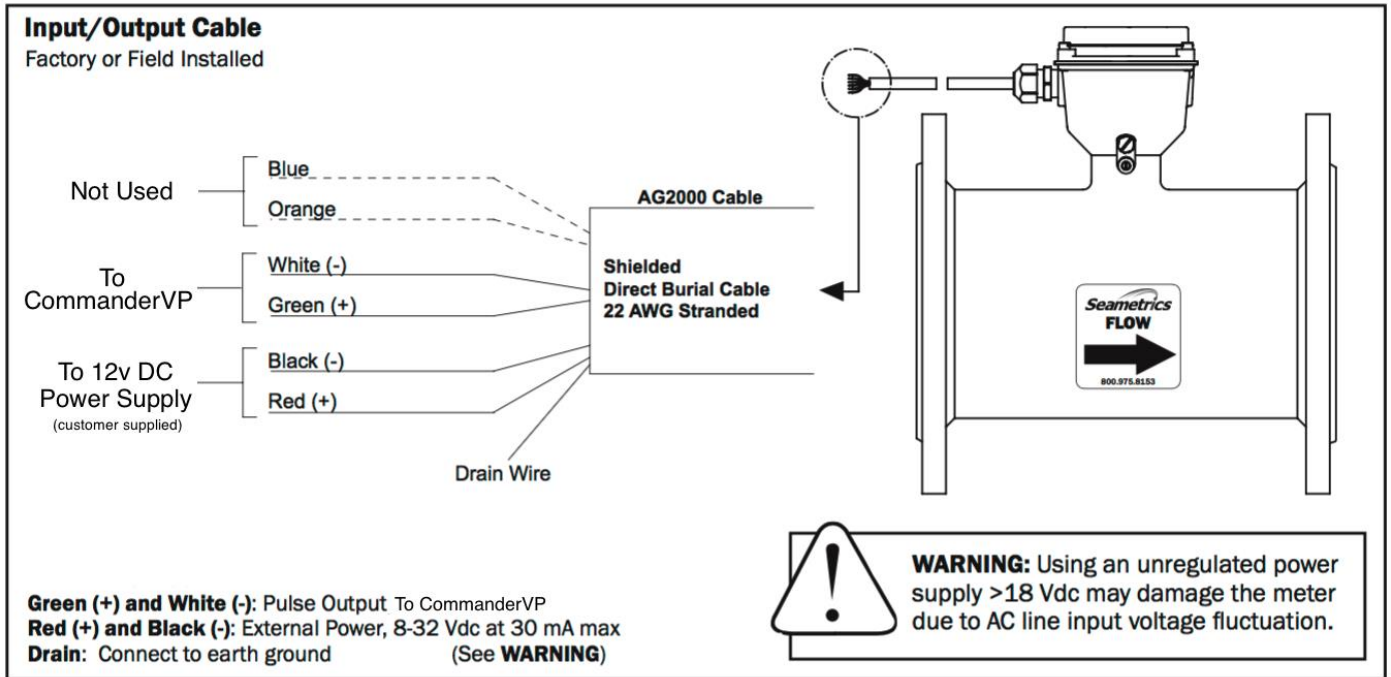

**Note:** The Seametrics AG2000 can come programmed for High-Frequency pulses or Standard Low Frequency Scaled Pulse Output (10 or 100 gallons per pulse) – be sure to choose the correct version (HF or LF) in the AgSense unit configuration.

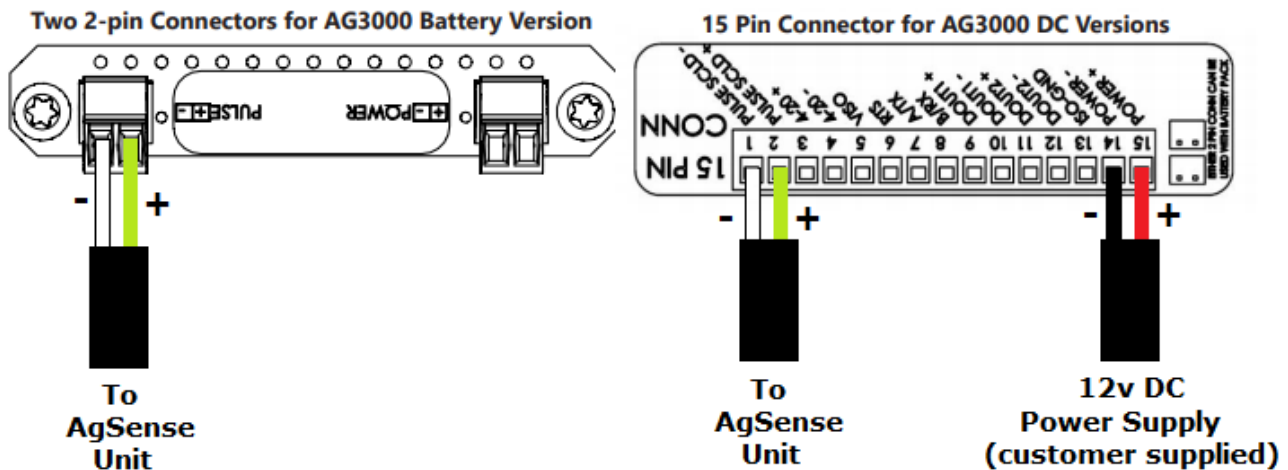

**Note2:** When using external power supply with these Seametrics Flow Meters, you should add a jumper wire from Black (12v-) to the White (pulse -) going to the ICON Link so that all ground wires are connected together.

## Wire Connections for the Seametrics AG2000, AG3000/Valley Flow Meter Cont.

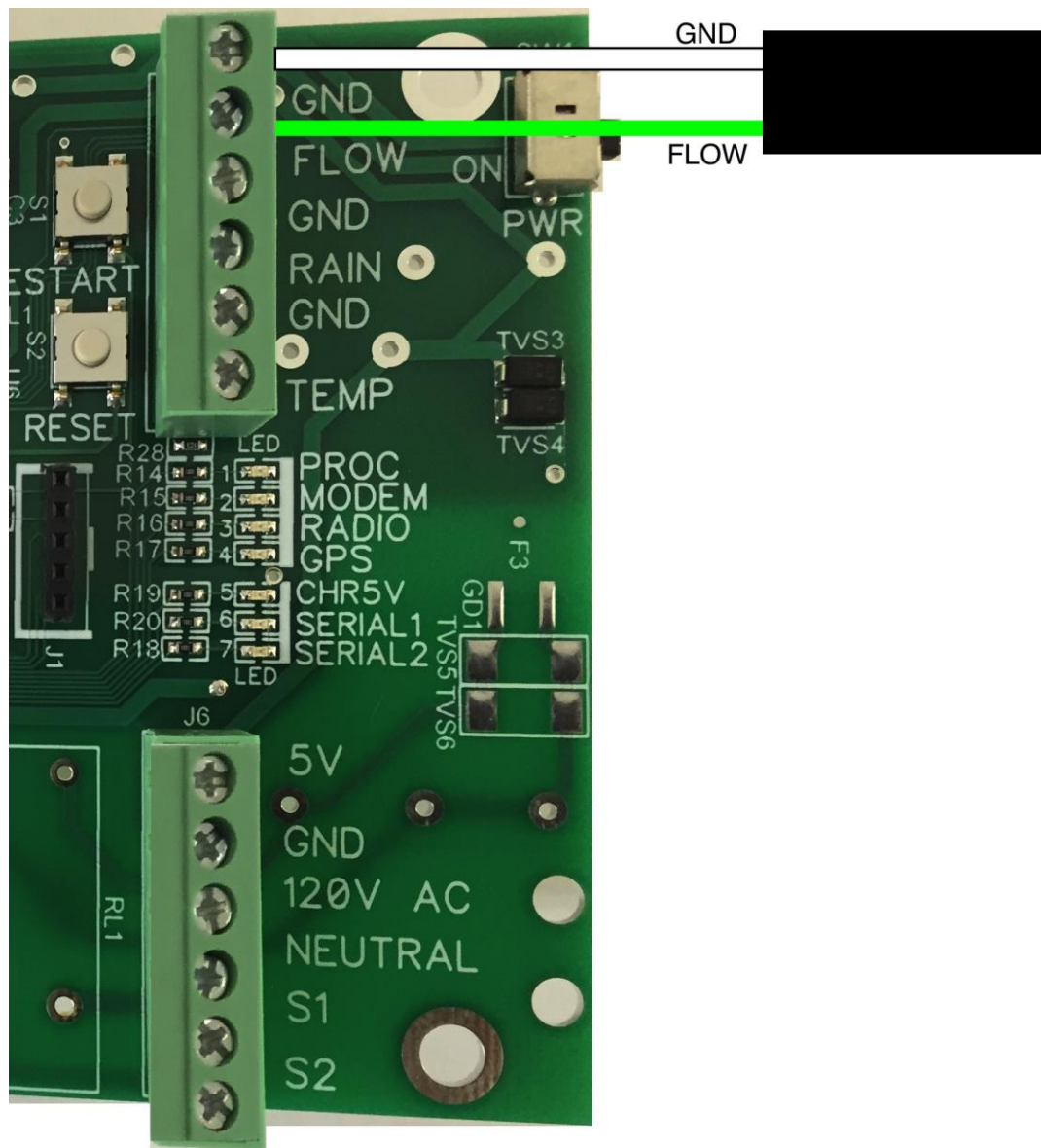

1. Install the White Wire from the Seametrics Flow Meter into any terminal marked **GND** as shown in the picture above.
2. Install the Green Wire from the Seametrics Flow Meter into the terminal marked **FLOW** as shown in the picture above.

# Wire Connections for the Endress Hauser Promag P 50/53 Series Flow Meter

120v powered meter shown – meter must be ordered the correct type with terminals 24 and 25 setup as Frequency Output (pulses)

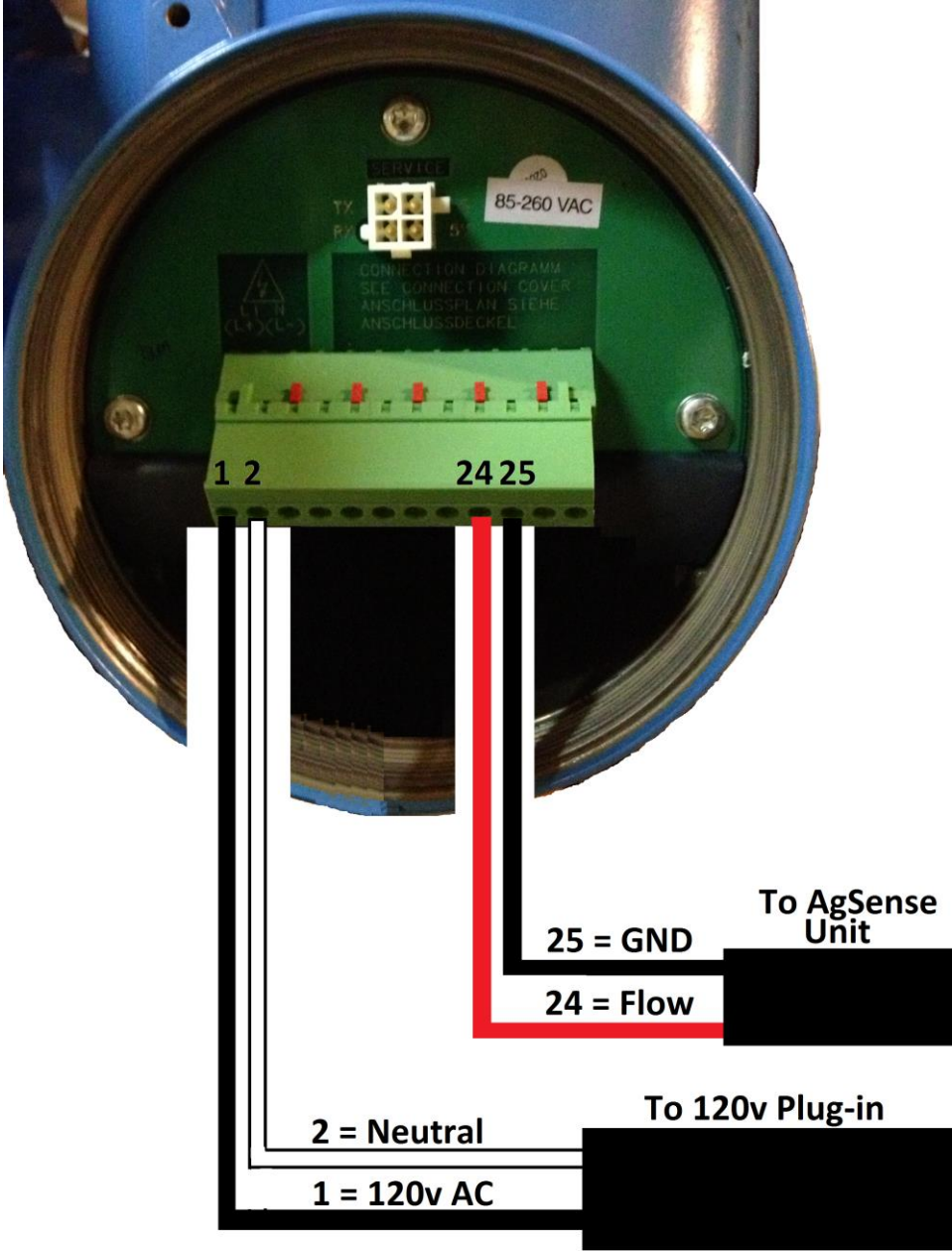

## Wire Connections for the Endress Hauser Promag P 50/53 Series Flow Meter Cont.

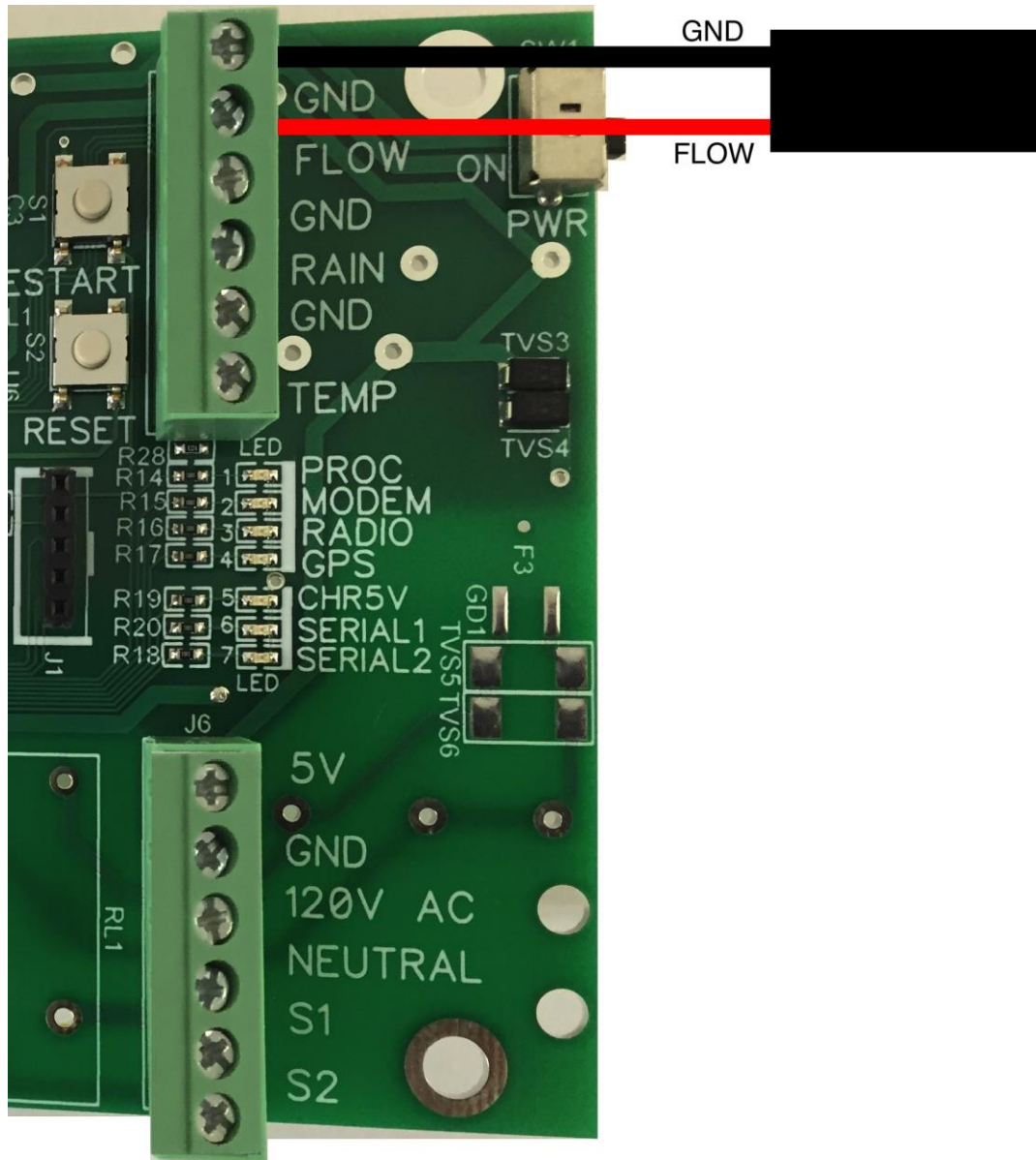

1. Install the Black Wire from the EH Flow Meter into any terminal marked **GND** as shown in the picture above.
2. Install the Red Wire from the EH Flow Meter into the terminal marked **FLOW** as shown in the picture above.
3. Using the menu on the EH flowmeter, be sure that the display of the flowmeter is set to gallons per minute. Then, using the menu on the EH flowmeter, set the pulse output to 10 gallons per pulse.

# Wire Connections for the Siemens MAG5000 Series Flow Meters

120v powered meter shown

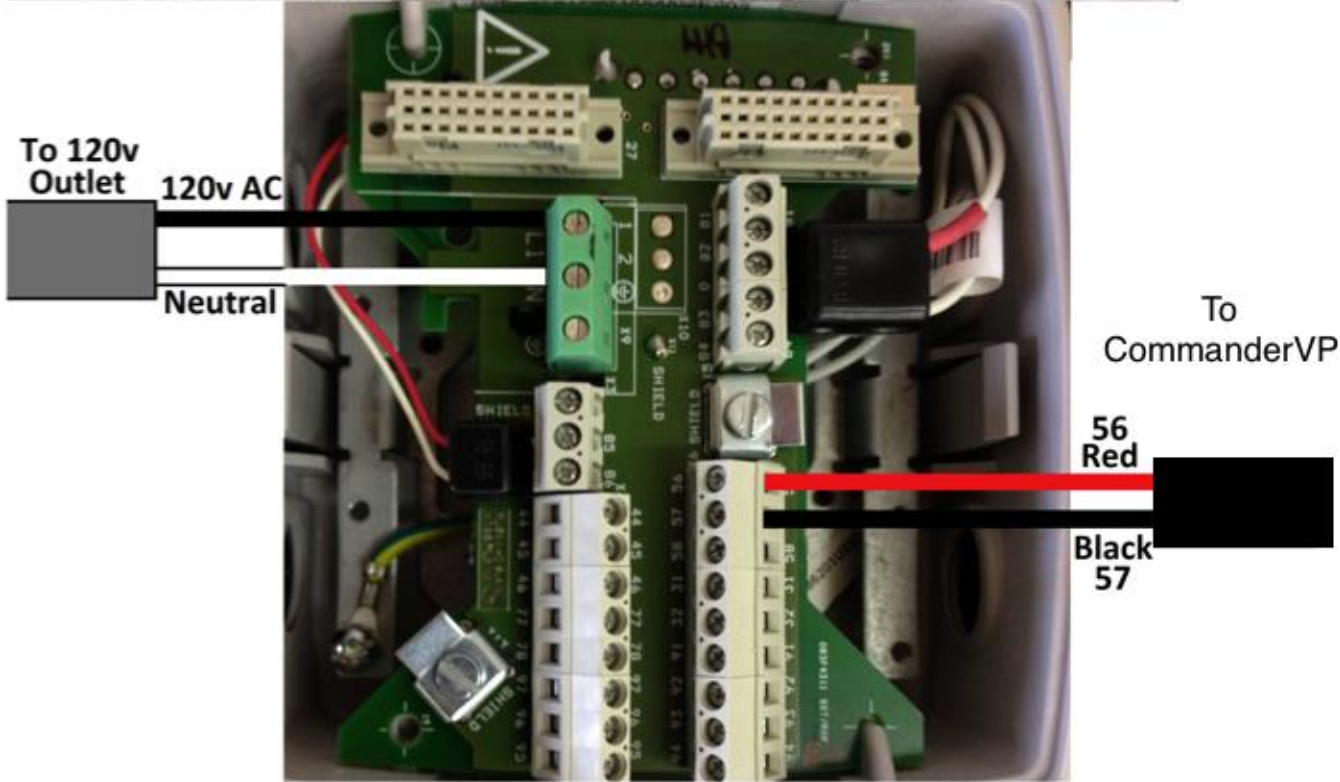

In the Siemens MAG5000 Menu, you must make sure the following is set:

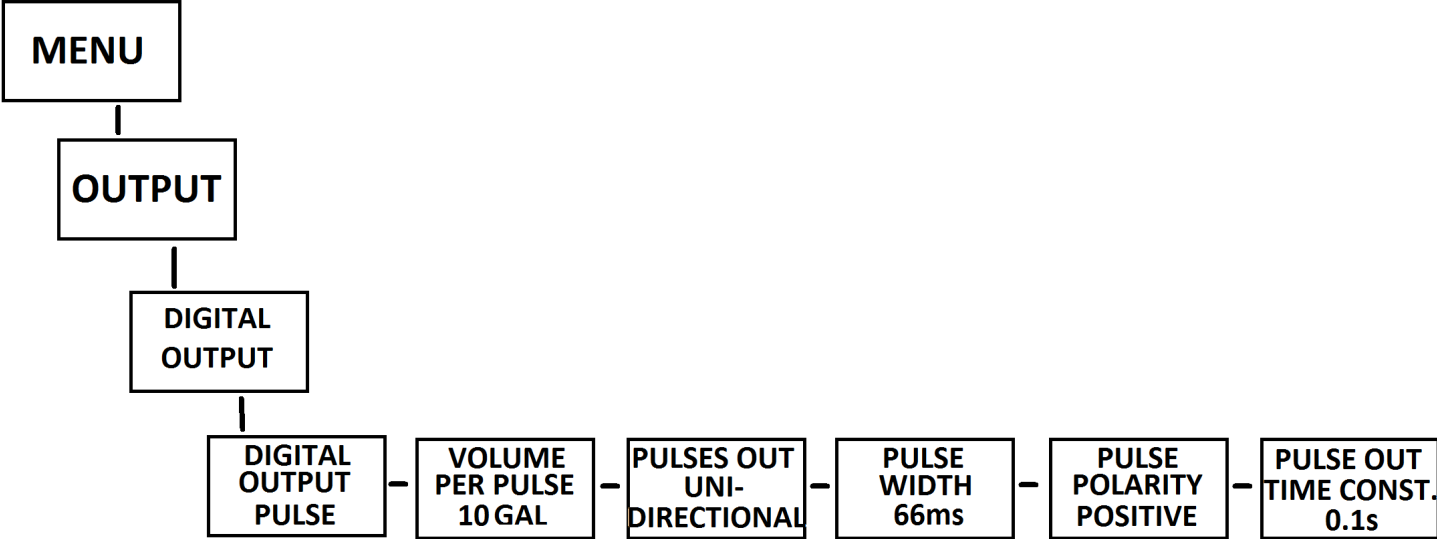



## Wire Connections for the Siemens MAG5000 Series Flow Meters Cont.

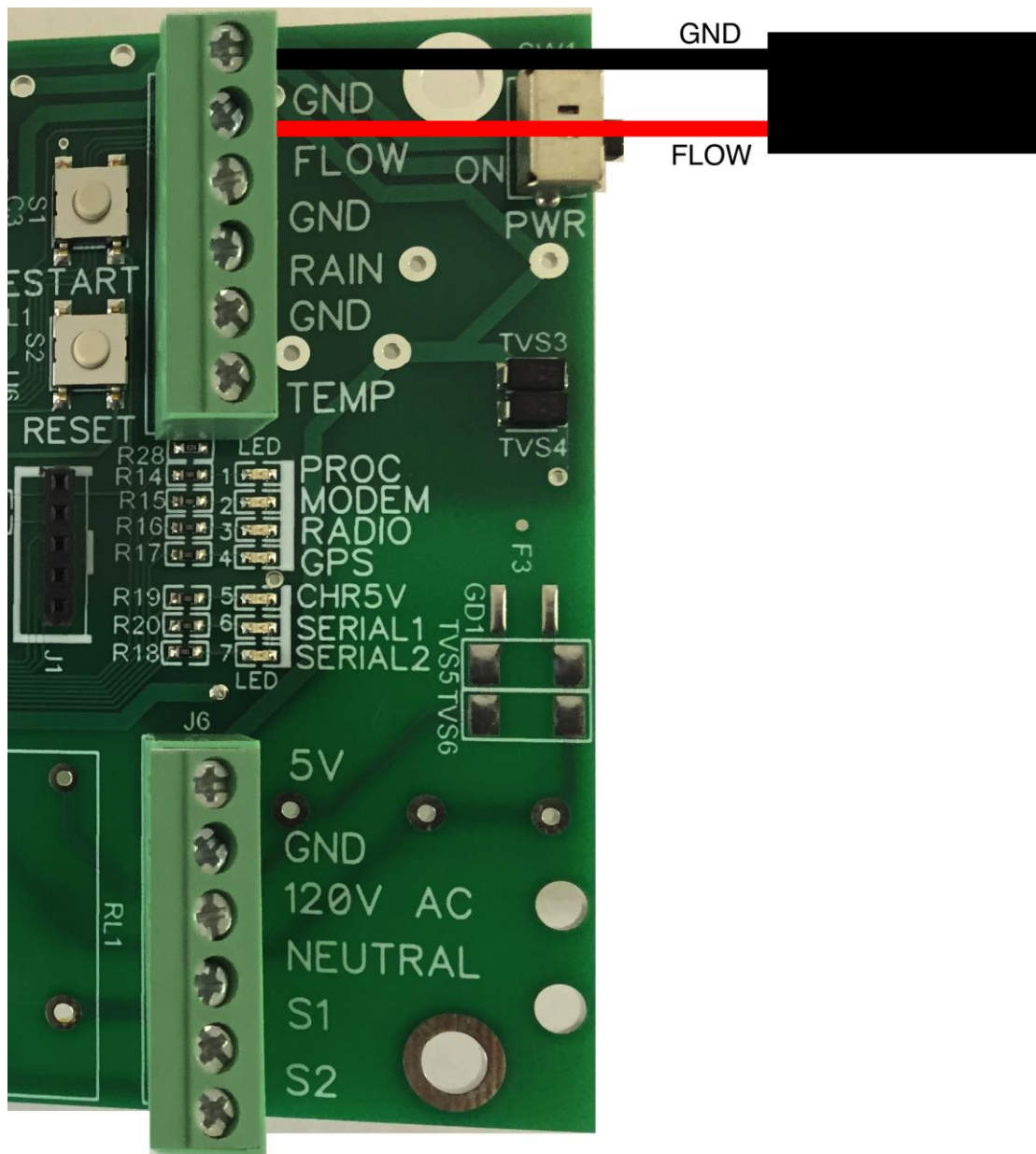

1. Install the Black Wire from the Siemens Flow Meter into any terminal marked **GND** as shown in the picture above.
2. Install the Red Wire from the Siemens Flow Meter into the terminal marked **FLOW** as shown in the picture above.
3. Set the Config on Wagnet for this unit to Siemens, and 10 gallons per pulse.

# Wire Connections for the Seametrics FT520 Display / PE102 Flow Meter

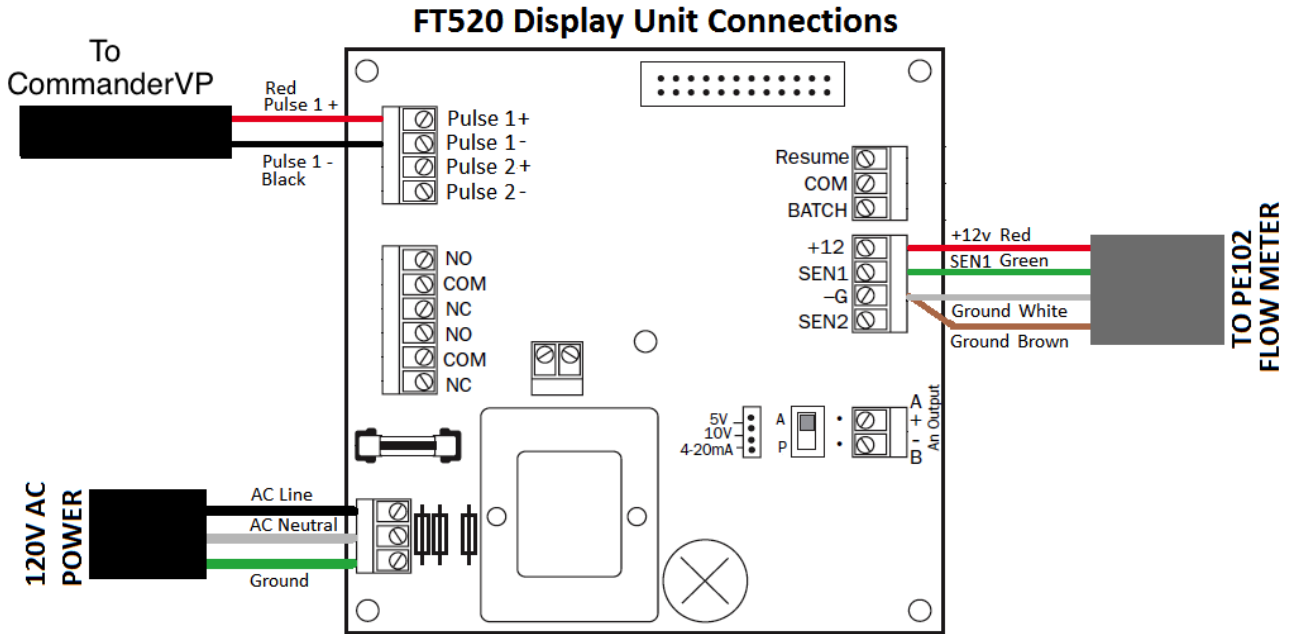

Connect the PE102 Flow Meter, the AC Power, and a cable to the CommanderVP unit as shown.

Use the SET button and the arrows on the FT520 display to change the flow rate to Gallons per Minute as shown below:



Use the SET button and the arrows on the FT520 display to set the decimal point for the display as shown below:



Use the SET button and the arrows on the FT520 display to set the K-FACTOR as shown below: (use the actual K-Factor in the documentation for your specific flow meter – the number below is only an example.)



Use the SET button and the arrows on the FT520 display to set the Pulse Output to the correct scale as shown below:





# Wire Connections for the GF Signet 9900 Flow Transmitter

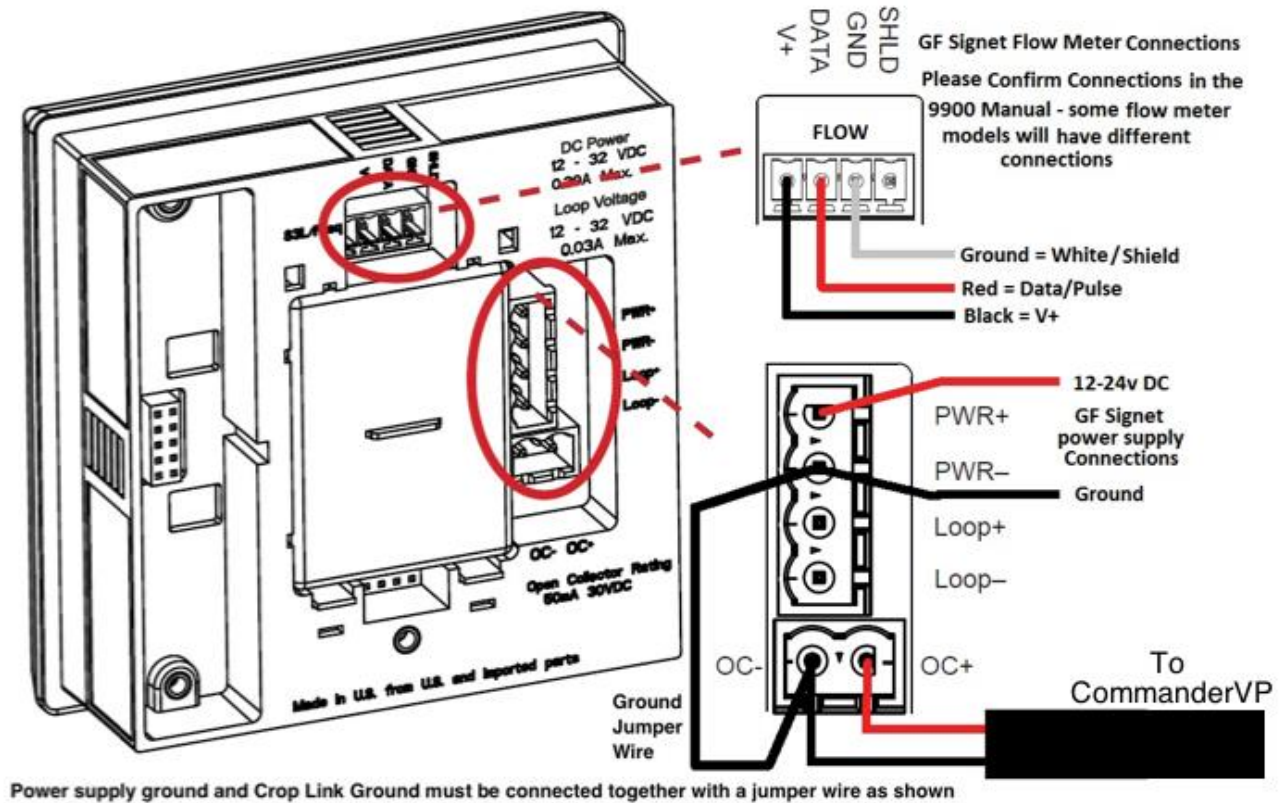

Power supply ground and Crop Link Ground must be connected together with a jumper wire as shown

Connect the Flow Meter, the DC Power, and a cable to the CommanderVP unit as shown above.

## **GF Signet 9900 settings:**

Hold down the **Enter** button for more than 3 seconds to enter the settings menus. When asked for a password or code, the default is: ▲▲▲▼

### **INPUT MENU**

1. Set the sensor TYPE to FLOW.
2. Set the sensor NAME to FLOW.
3. Set the SENSITIVITY to 100 (if using with small flow meters, this number may need to be set lower. (see GF Signet 9900 Manual)
4. Set the AVERAGE to OFF.
5. Set the TOT UNITs to GALLONS
6. Set the FLOW UNITS to GPM (gallons per minute)
7. Set the SENSOR to FREQ for flow meters that output a frequency/pulse (most flow meters) – or if you are using a S3L digital flow sensor, set SENSOR to S3L
8. Press the ▲ and ▼ arrows at the same time to exit this menu.

### **RELAY MENU**

The RELAY menu enables the open collector (OC+, OC-) output to send pulse data to the CommanderVP unit. The Relay 1 settings are what turns on the Open Collector output, change the settings as follows:

1. Set R1 to NORMAL OPEN
2. Set R1 MODE to VOL PULS
3. Set R1 VOLUME to 10.00
4. Set R1 PULSE WIDTH to 0.1
5. Press the ▲ and ▼ arrows at the same time to exit this menu.
6. Press the ▲ and ▼ arrows again at the same time to exit the settings menus and return to normal operation.

Continue to the next page for CommanderVP Unit wiring.

Connect the wires from the GF Signet 9900 into the CommanderVP:

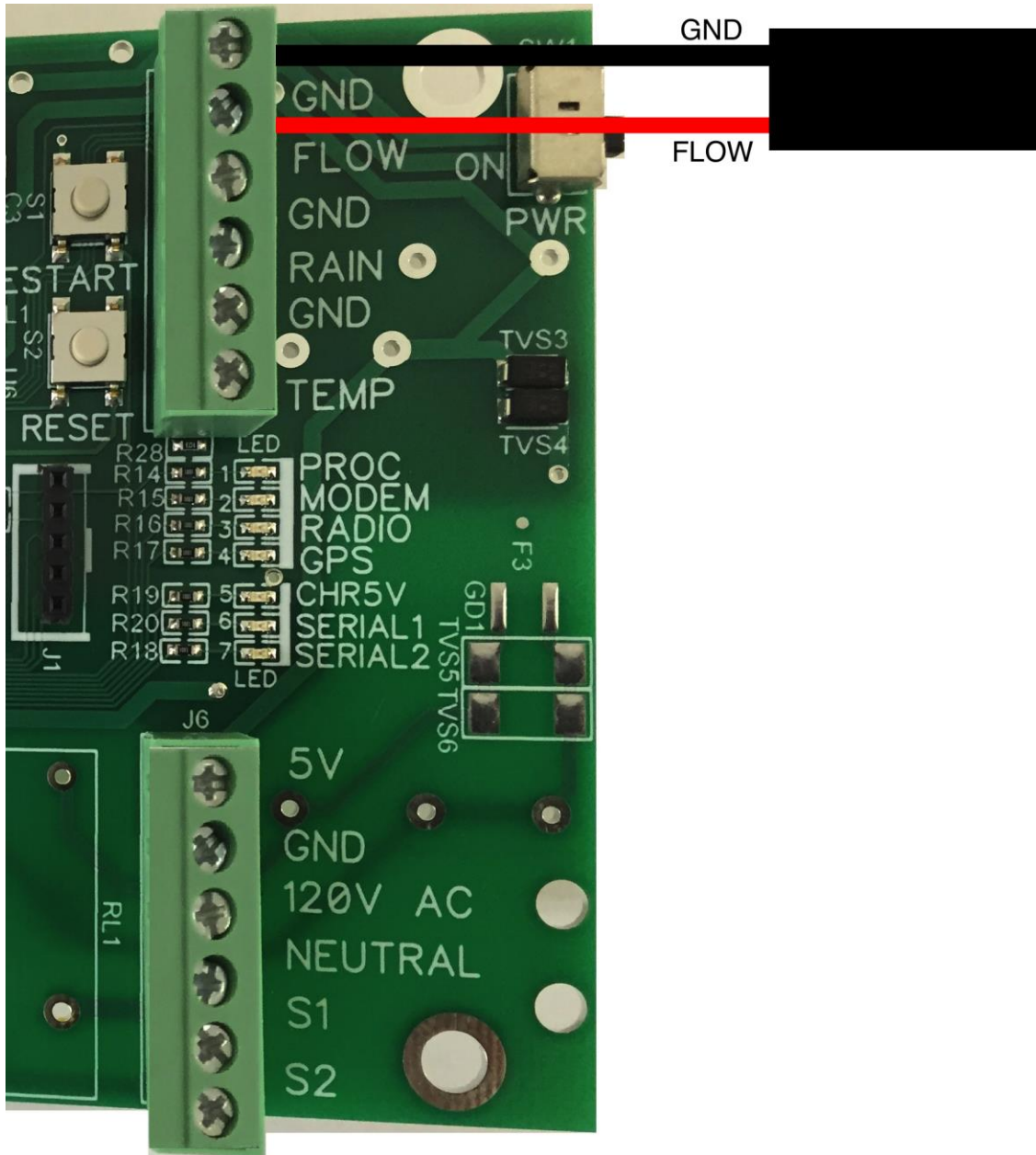

1. Install the Red Wire from the GF Signet 9900 into the terminal marked **FLOW** as shown in the picture above.
2. Install the Black Wire from the GF Signet 9900 into any terminal marked **GND** as shown in the picture above.
3. Set the Config on Wagnet for this unit to GF Signet 8550 / 9900, and 10 pulses per gallon.

# Wire Connections for the GF Signet 2551 Mag Flow Meter with Frequency Output



## 2551 Magmeter Connections

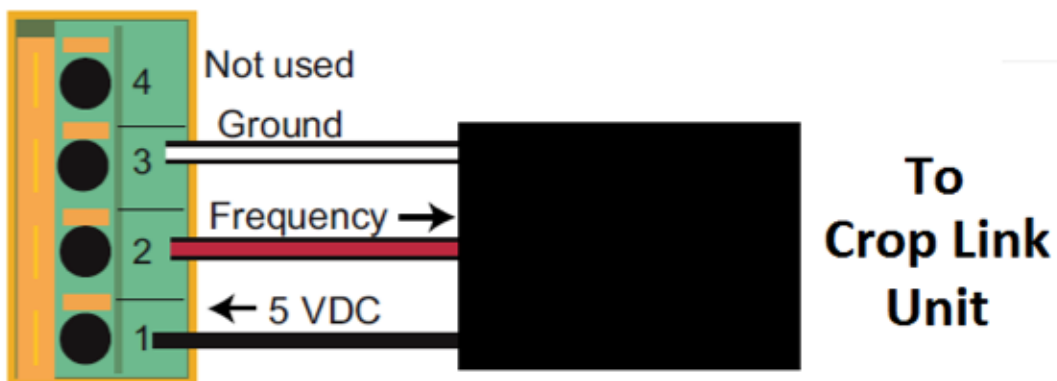

1. Make sure the jumper shown above is in place for this meter to output frequency.
2. Install a black wire into terminal 1 (5v input) in the 2551 Mag Meter.
3. Install a red wire into terminal 2 (pulse output) in the 2551 Mag Meter.
4. Install a white wire into terminal 3 (ground) in the 2551 Mag Meter.



Connect the wires from the 2551 into the CommanderVP:

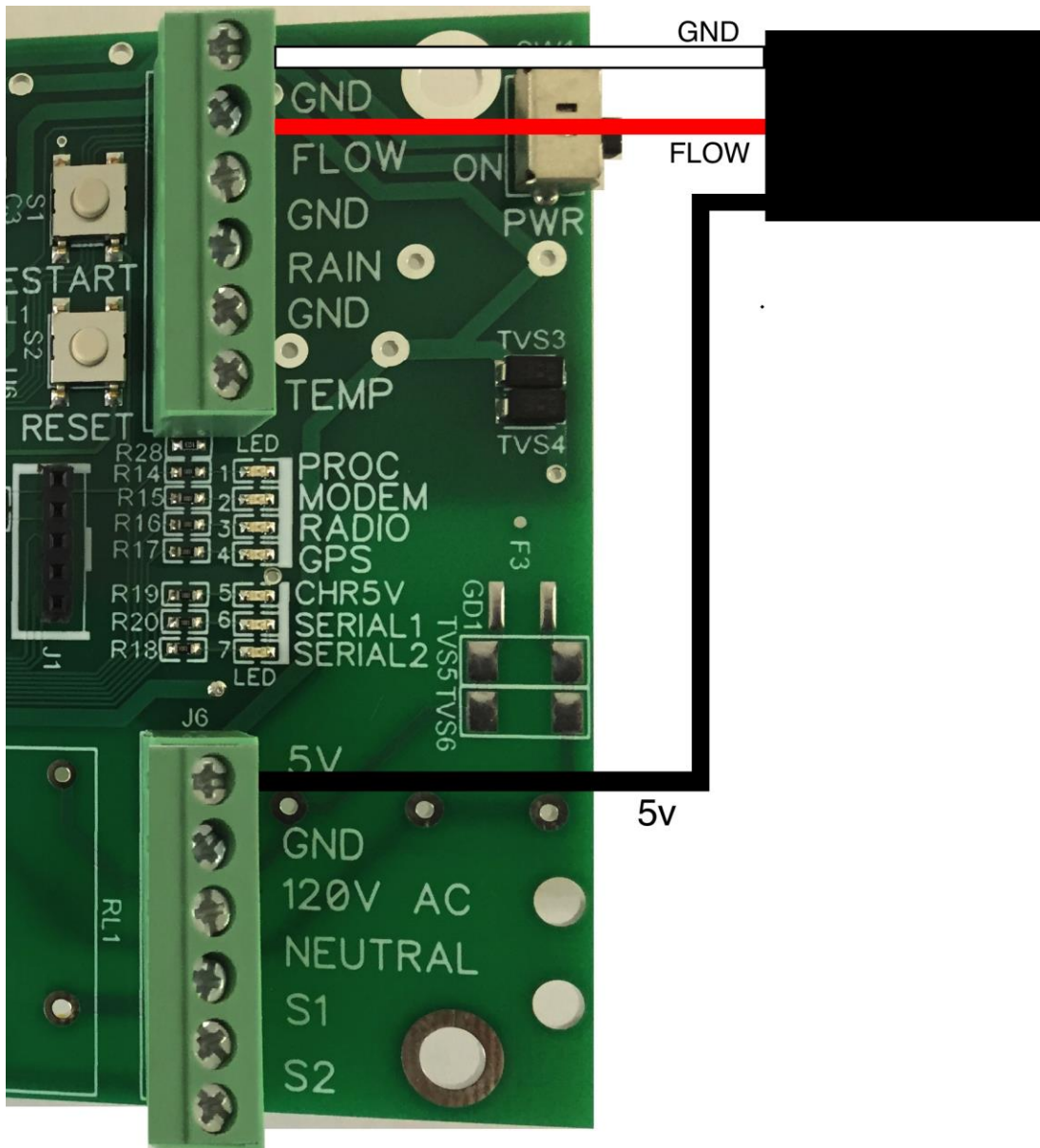

1. Install the Black Wire from the GF Signet Mag Meter into 5v terminal as shown in the picture above, with the other 5v wire that is already there. (there will be 2 wires in the 5v terminal at the same time)
2. Install the White Wire from the GF Signet Mag Meter into any terminal marked **GND** as shown in the picture above.
3. Install the Red Wire from the GF Signet Mag Meter into the terminal marked **FLOW** as shown in the picture above.

# Wire Connections for the McCrometer FlowCom Flow Meter

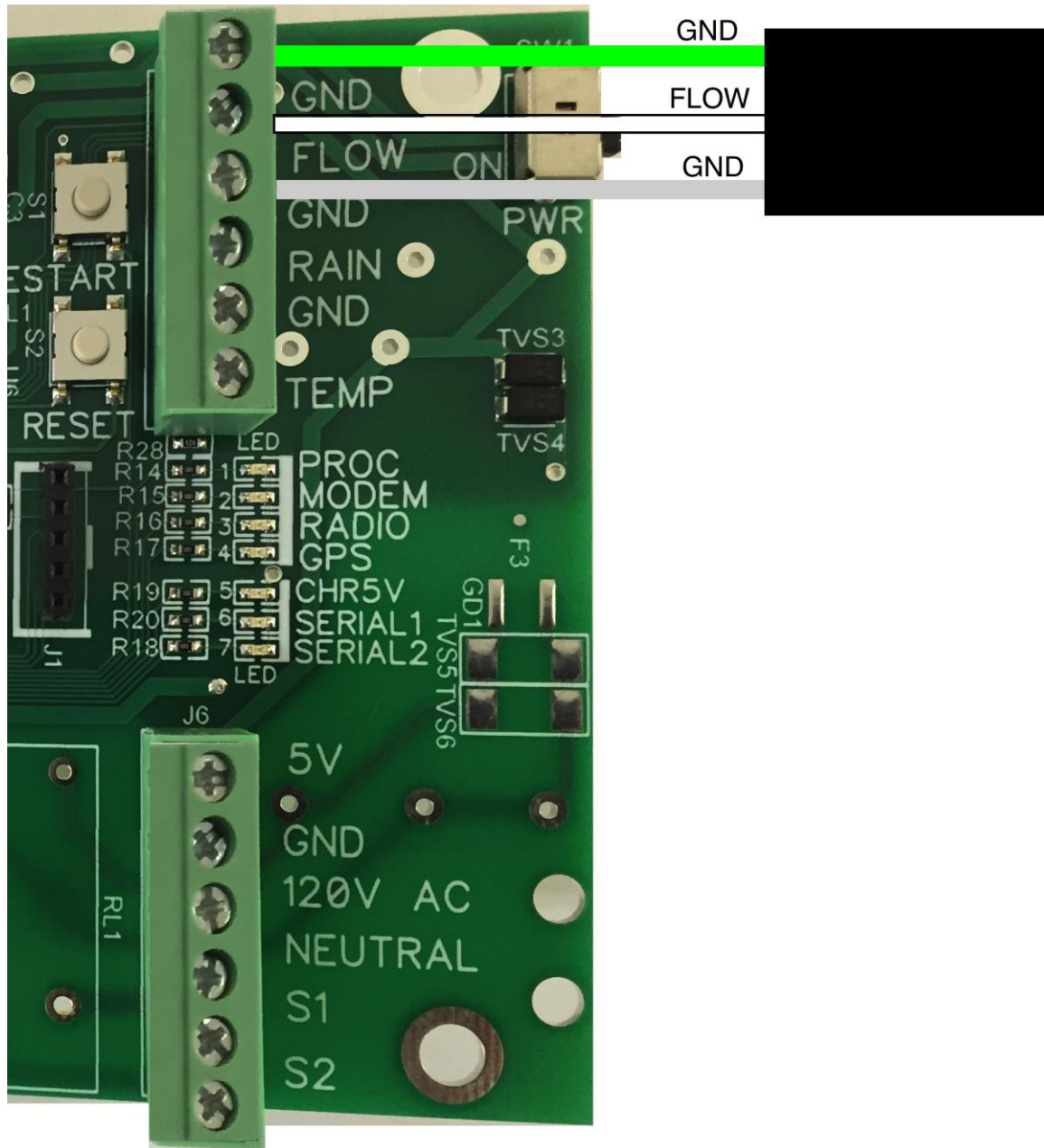

1. Install the Green Wire from the McCrometer Flow Meter into any terminal marked **GND** as shown in the picture above.
2. Install the Bare Wire from the McCrometer Flow Meter into any terminal marked **GND** as shown in the picture above.
3. Install the White Wire from the McCrometer Flow Meter into the terminal marked **FLOW** as shown in the picture above.

# Wire Connections for the McCrometer McMag 3000 Or EA-618-02 Flow Meters

## McMag 3000 flow meter connections

The Mc Mag<sup>3000</sup> has two external connectors on the downstream side of the electronics enclosure. The two connectors are for:

- 1. a 5-pin connector for 24 VDC power (Optional - see your McCrometer dealer for this cable and power supply)
- 2. a 7-pin connector for pulse output 1 See Figure 15.

NOTE: The Mc Mag<sup>3000</sup> MUST BE configured at the factory for the optional pulse output as requested by the customer at the time of order.



Figure 15: External Connectors

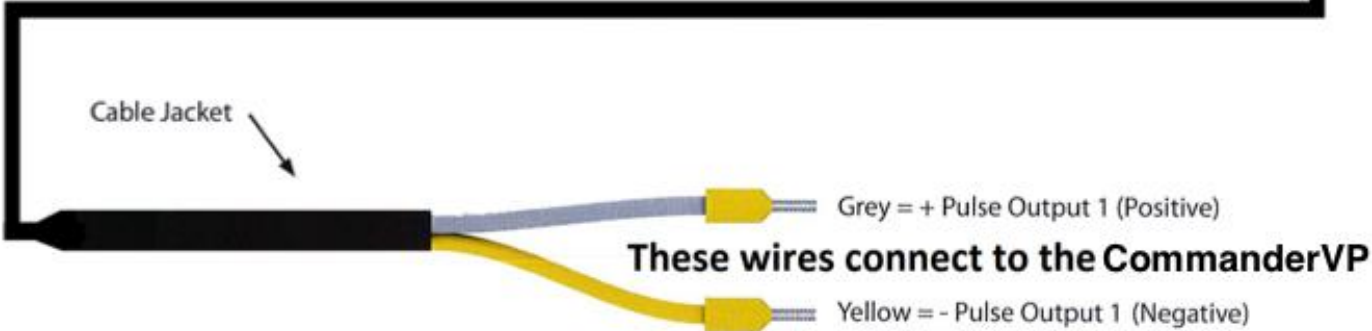
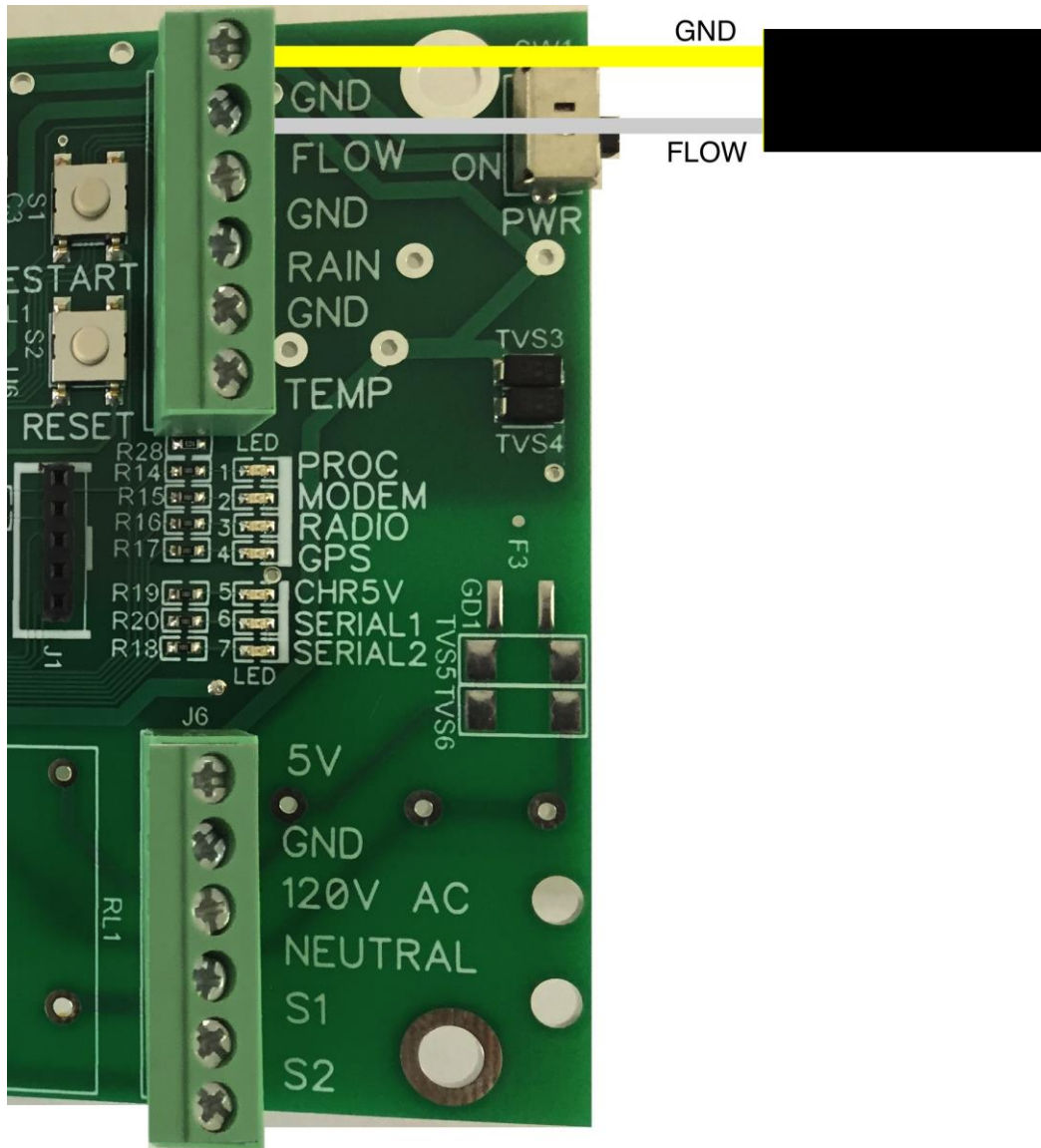

Figure 18: 7-Pin Pulse Output Cable Wiring Color Scheme

# CommanderVP Wiring for McMag 3000 / EA-618-02



1. Install the Yellow Wire from the McCrometer Flow Meter into any terminal marked **GND** as shown in the picture above.
2. Install the Grey Wire from the McCrometer Flow Meter into the terminal marked **FLOW** as shown in the picture above.
3. On the wagnet website, Config Tab, select McMag3000 from the Digital 1 Flow selection, and set the gallons per pulse of this flow meter to 100 (this is the normal amount set by the factory when the flow meter was manufactured)

## Wire Connections for the Siemens Sitrans FM MAG 8000 Flow Meter

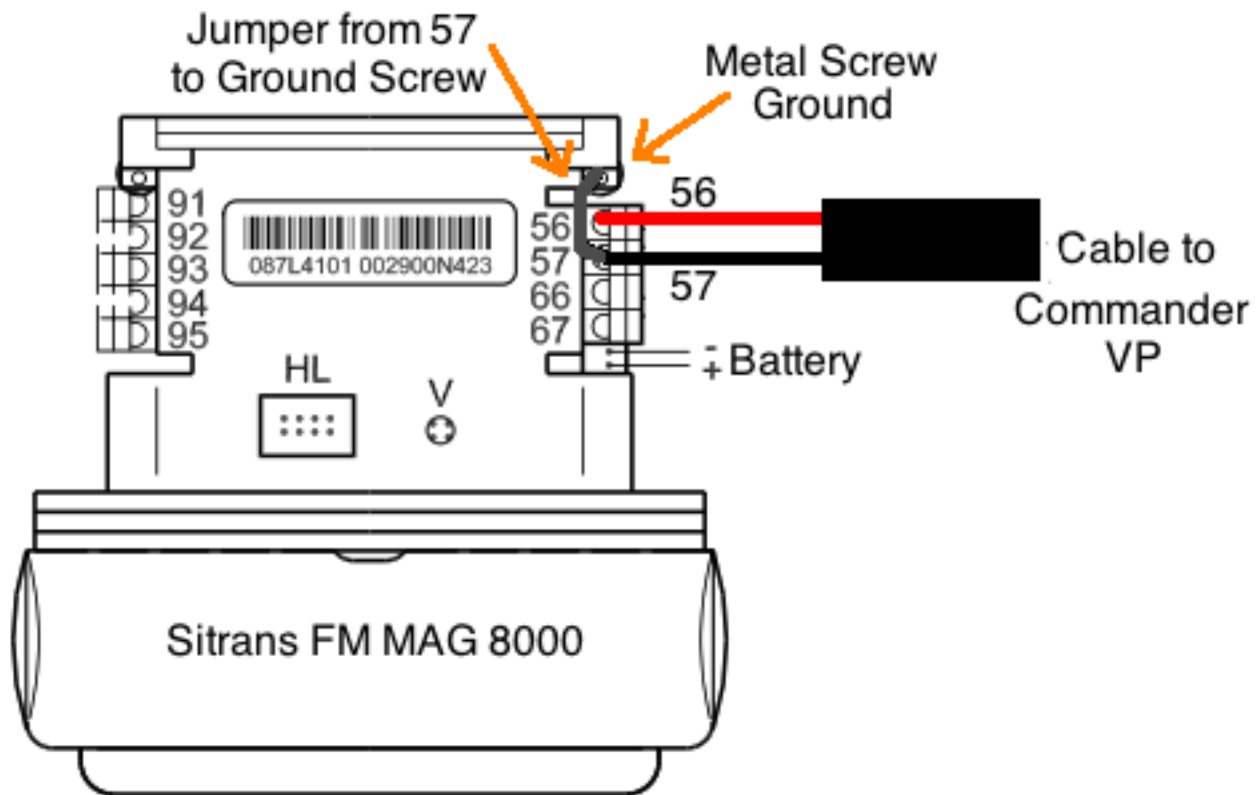

1. Install a Red wire into terminal 56 of the flow meter. This wire will go to the CommanderVP Unit.
2. Install a Black wire into terminal 57 of the flow meter. This wire will go to the CommanderVP Unit.
3. Also install a jumper wire into terminal 57 of the flow meter and connect the opposite end of the wire to one of the metal screws on the brackets that support the circuit boards inside the flow meter.

## CommanderVP Connections for the Siemens Sitrans FM MAG 8000 Flow Meter

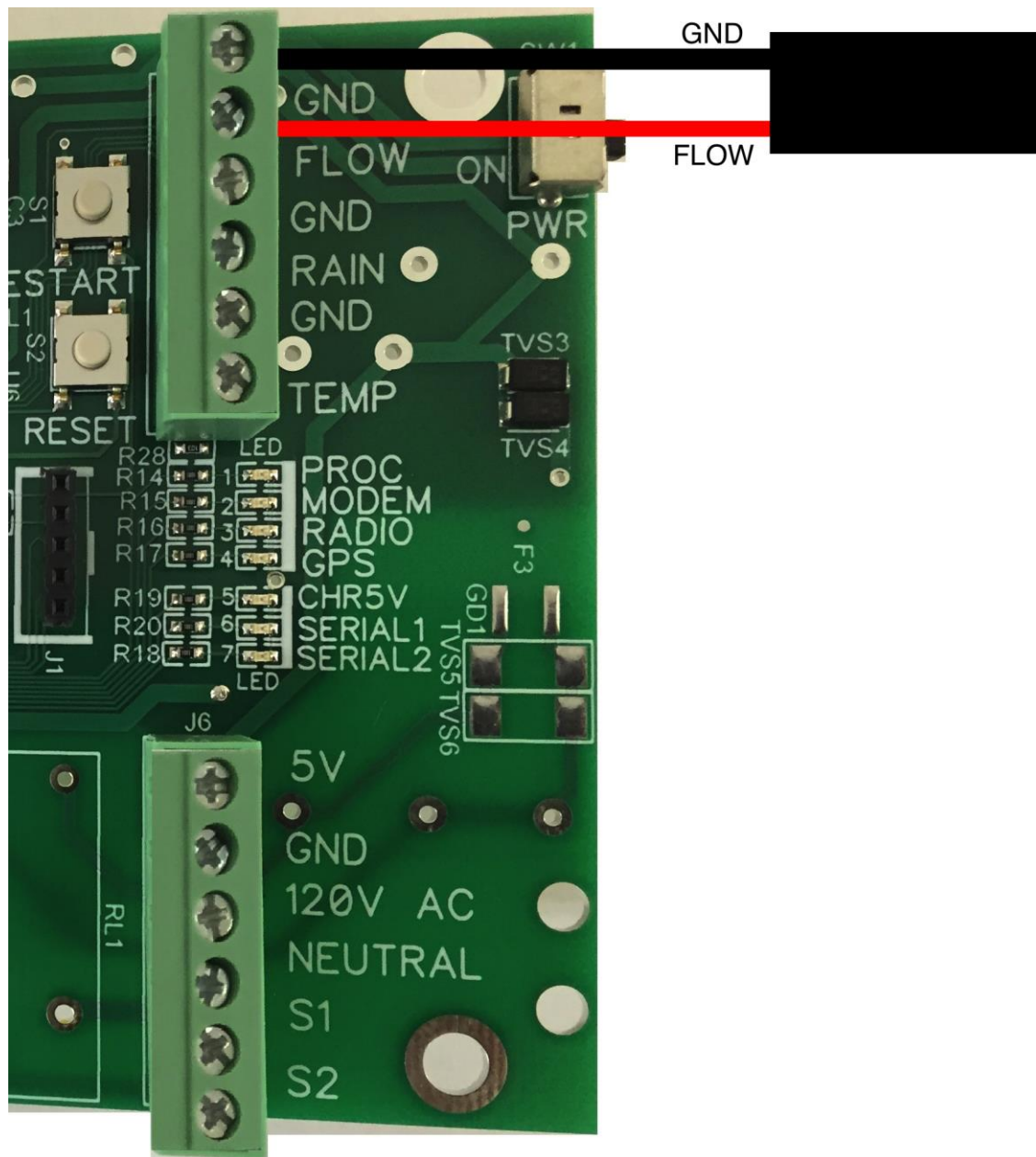

1. Install the Black Wire from the Sitrans Flow Meter into any terminal marked **GND** as shown in the picture above.
2. Install the Red Wire from the Sitrans Flow Meter into the terminal marked **FLOW** as shown in the picture above.

# Wire Connections for the Greyline AVFM 5.0 Flow Meter



## Wires To CommanderVP

1. Install a Red wire into the Relay 1 Normally Open terminal of the flow meter. This wire will go to the CommanderVP.
2. Install a Black wire into Relay 1 Common terminal of the flow meter. This wire will go to the CommanderVP.
3. Make sure the Menu Settings have been set to Gallons Per Minute, and Relay 1 set for pulse output as shown in the photos on the next page.

## AVFM 5.0 Menu Settings

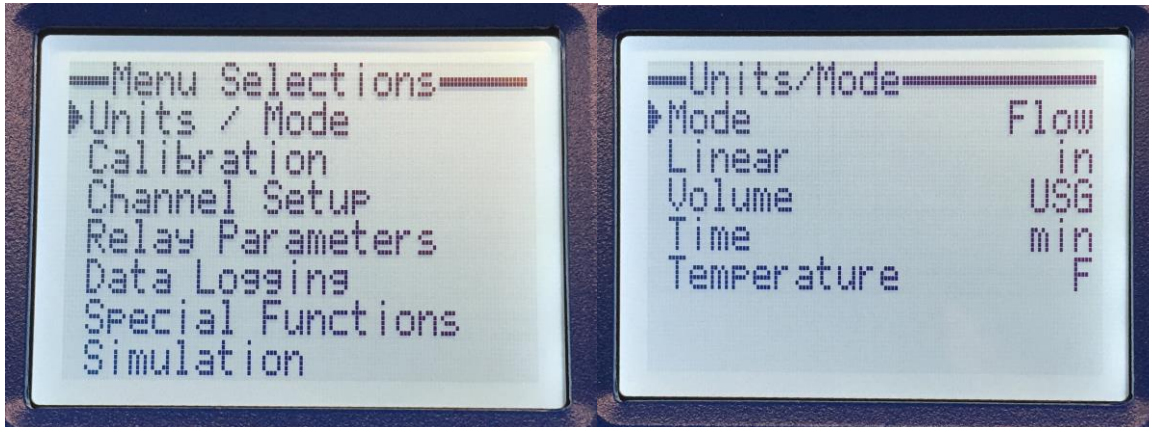

**Make certain the units is setup as Gallons Per Minute as shown above**

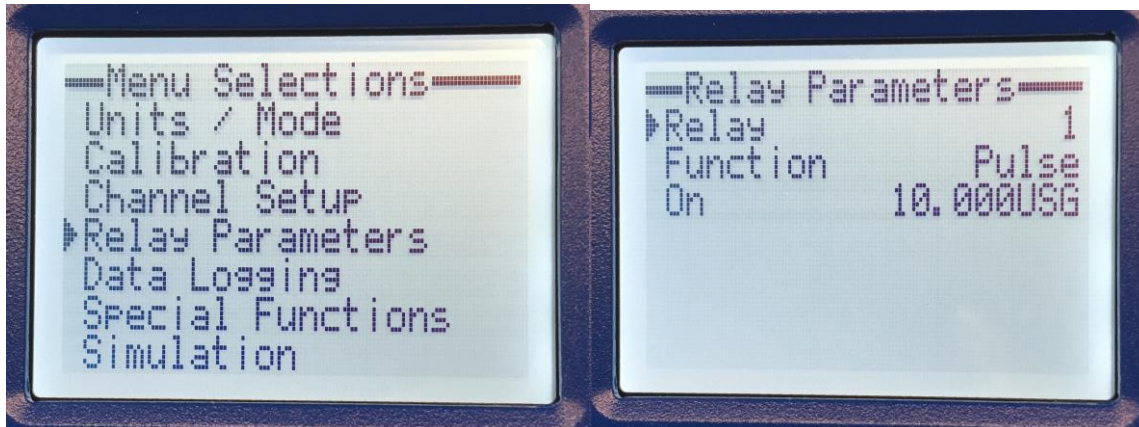

**Make certain that Relay 1 is setup for Pulse operation, and set the gallons per pulse (10 gallons per pulse shown above)**

**Depending on the size of pipe/channel that you are measuring, you will**

**want to set the Gallons per pulse to a larger :**

**10.0=Small Pipe (less than 100 GPM)**

**100.0=Medium Pipe (100-1000 GPM)**

**1000.0=Large Pipe (1000+GPM)**



## CommanderVP Connections for the Greyline AVFM 5.0 Flow Meter

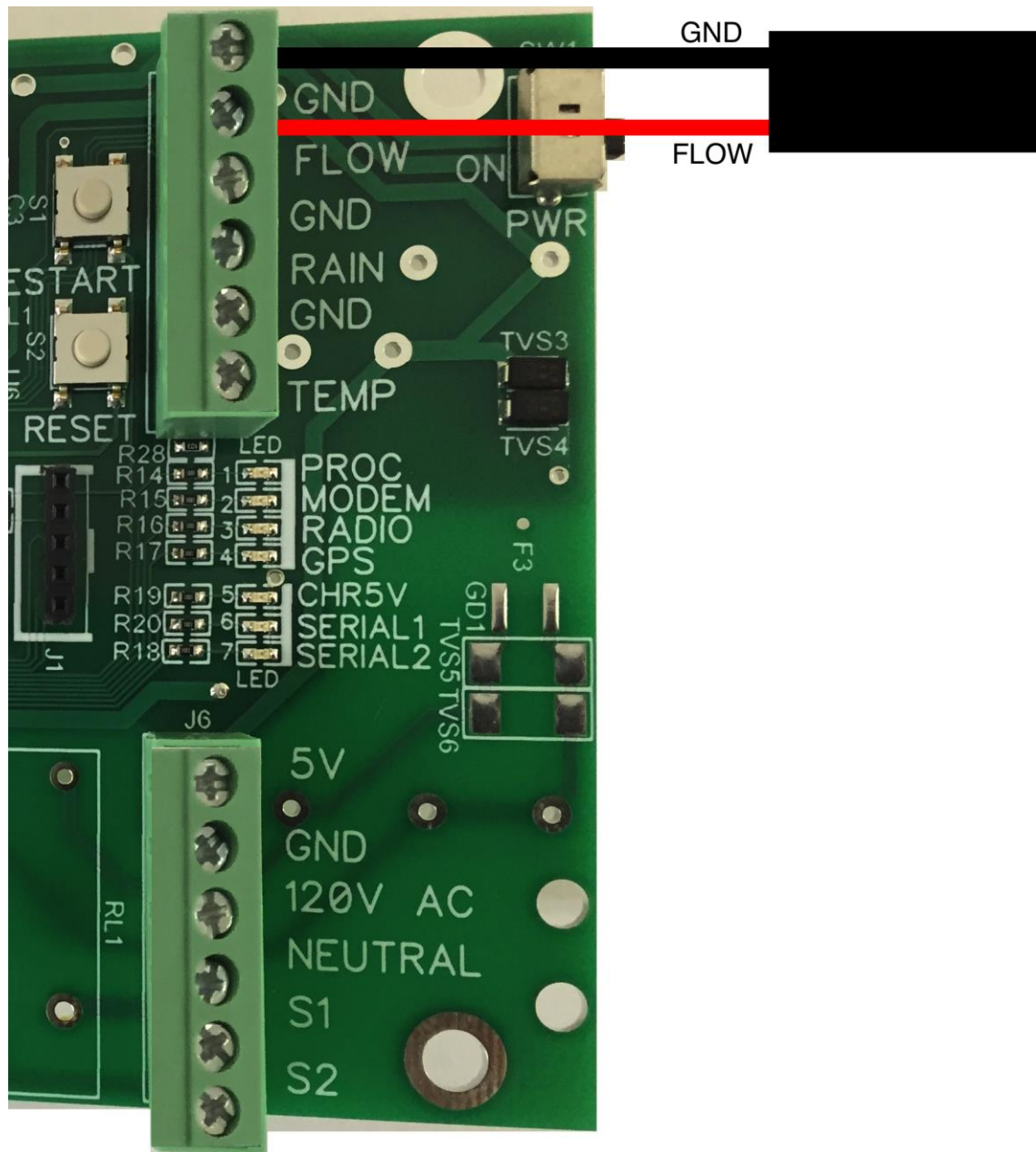

1. Install the Black Wire from the Greyline Flow Meter into any terminal marked **GND** as shown in the picture above.
2. Install the Red Wire from the Greyline Flow Meter into the terminal marked **FLOW** as shown in the picture above.

# Wire Connections for the Senninger Flo-Wise SC-3 Flow Meter

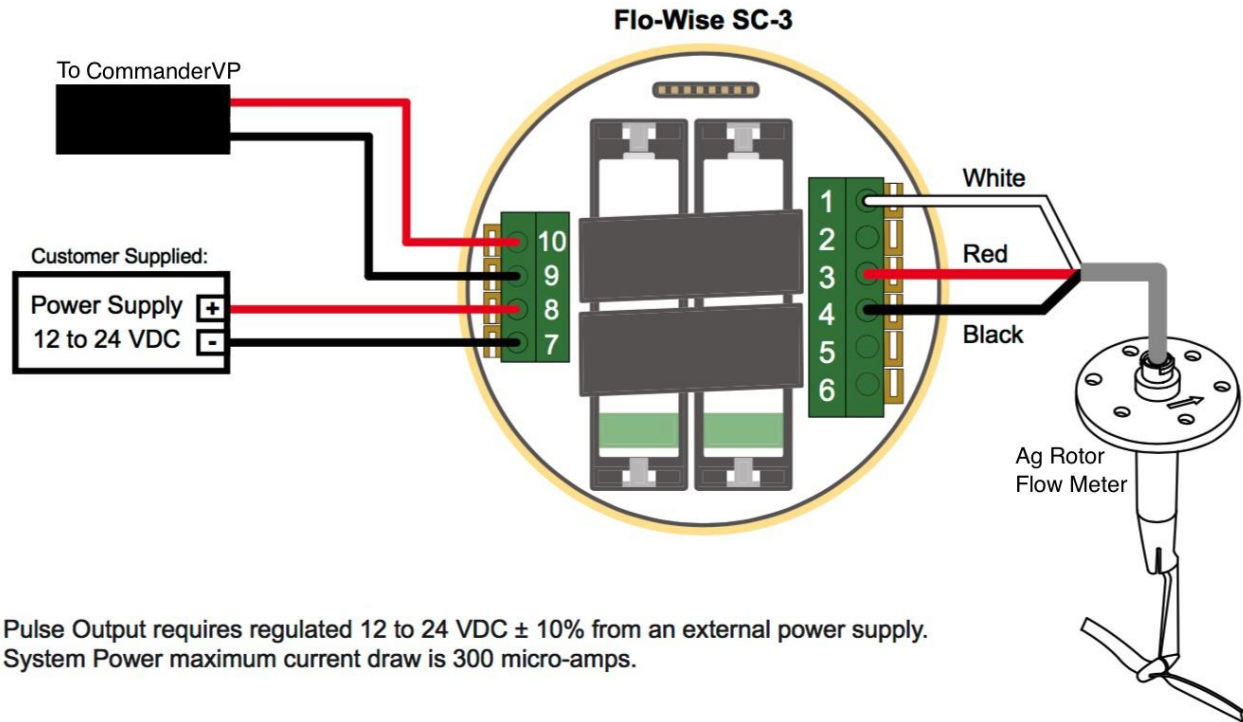

1. Install the wires from the flow meter to the SC-3 as shown (consult your flo-wise instruction manual for flow meter wiring variations).
2. Install the DC power supply to terminals 7 and 8 as shown above.
3. Install the pair of wires from the CommanderVP unit to terminals 9 and 10 as shown above.
4. Configure the SC-3 "Pulse Output" in the SC-3 menu to output a pulse every 100 gallons.

## CommanderVP Connections for the Senninger Flo-Wise SC-3 Flow Meter

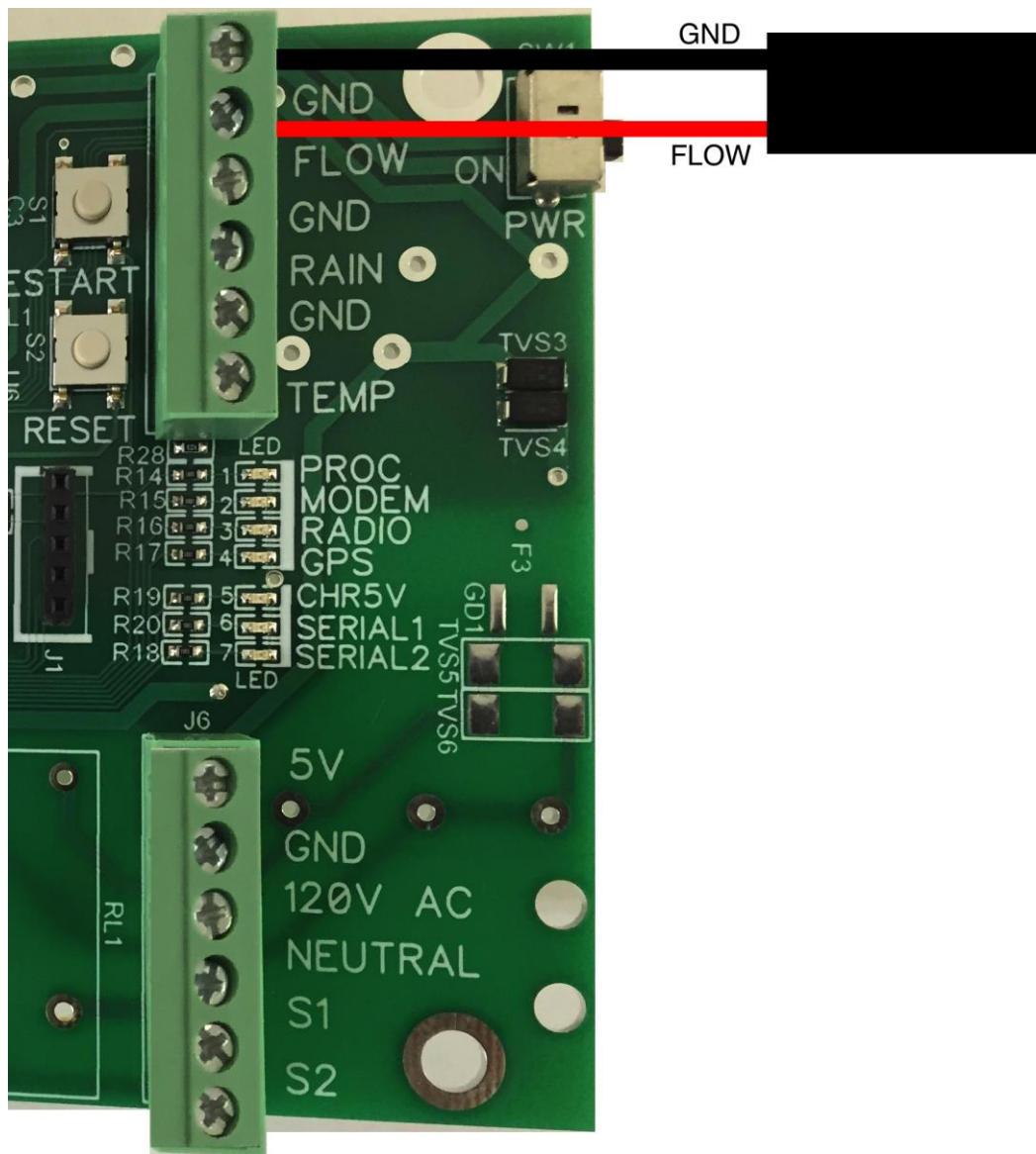

1. Install the Black Wire from the SC-3 Flow Meter into any terminal marked **GND** as shown in the picture above.
2. Install the Red Wire from the SC-3 Flow Meter into the terminal marked **FLOW** as shown in the picture above.
3. On the CommanderVP unit config page, choose GF Signet 8550/9900/SC-3 in the Digital 1 Options section, and enter 100 gallons per pulse. Then click Save Config at the bottom of the page.

# Wire Connections for the Banjo MFM300DC Flow Meter

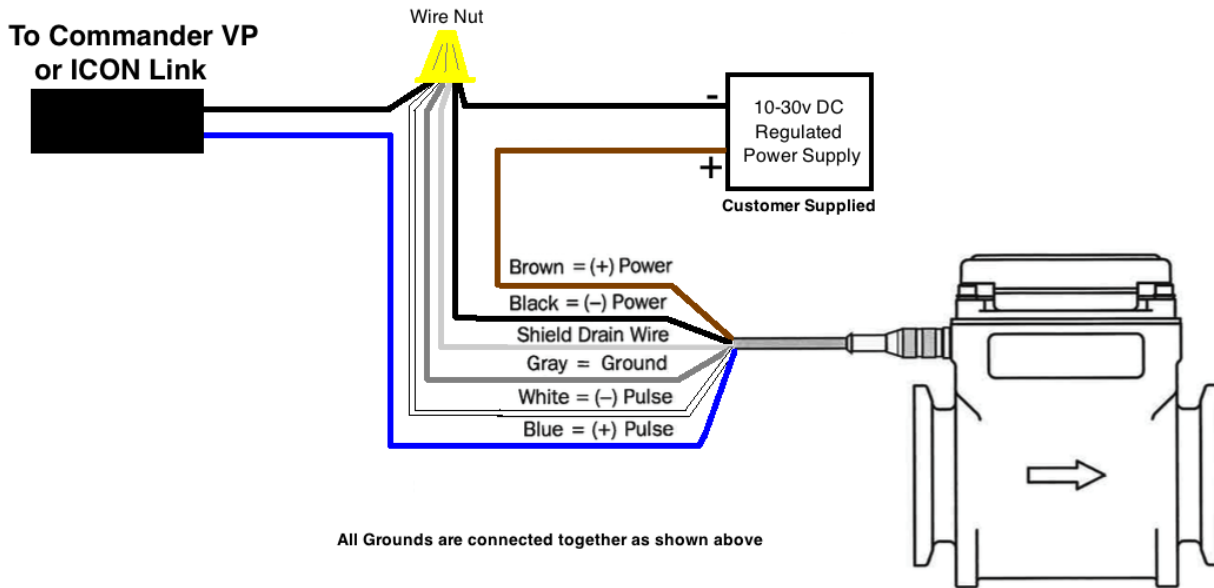

1. Install the brown power wire from the flow meter to + terminal of a 10-30v DC power supply as shown above.(not supplied by AgSense)
2. Install the 4 Ground wires from the flow meter, and the Ground wire from the CommanderVP / ICON Link unit into a wire nut with the – wire from the DC power supply as shown above. (all grounds connected together)
3. The Blue pulse output wire from the flow meter goes to the CommanderVP / ICON Link unit.
4. Install the See the next page for CommanderVP / ICON Link wiring.

## CommanderVP Connections for the Banjo MFM300DC Flow Meter

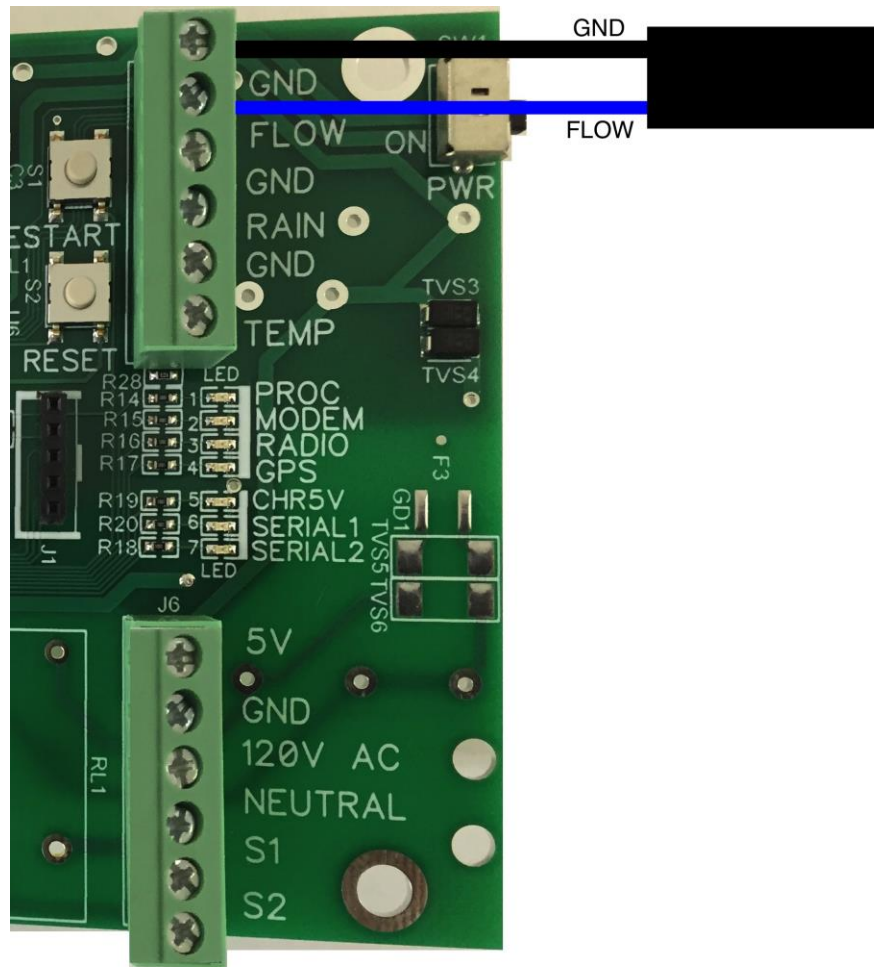

1. Install the Black Wire from the Flow Meter into any terminal marked GND as shown in the picture above.
2. Install the Blue Wire from the Flow Meter into the terminal marked
3. FLOW as shown in the picture above.
4. On the CommanderVP unit config page, choose Banjo in the Digital 1 Options section, and enter 13 Pulses per gallon (high frequency meters) or 1 pulse per gallon (standard frequency meters). Then click Save Config at the bottom of the page.

# Wire Connections for the Seametrics FT415 Flow Meter

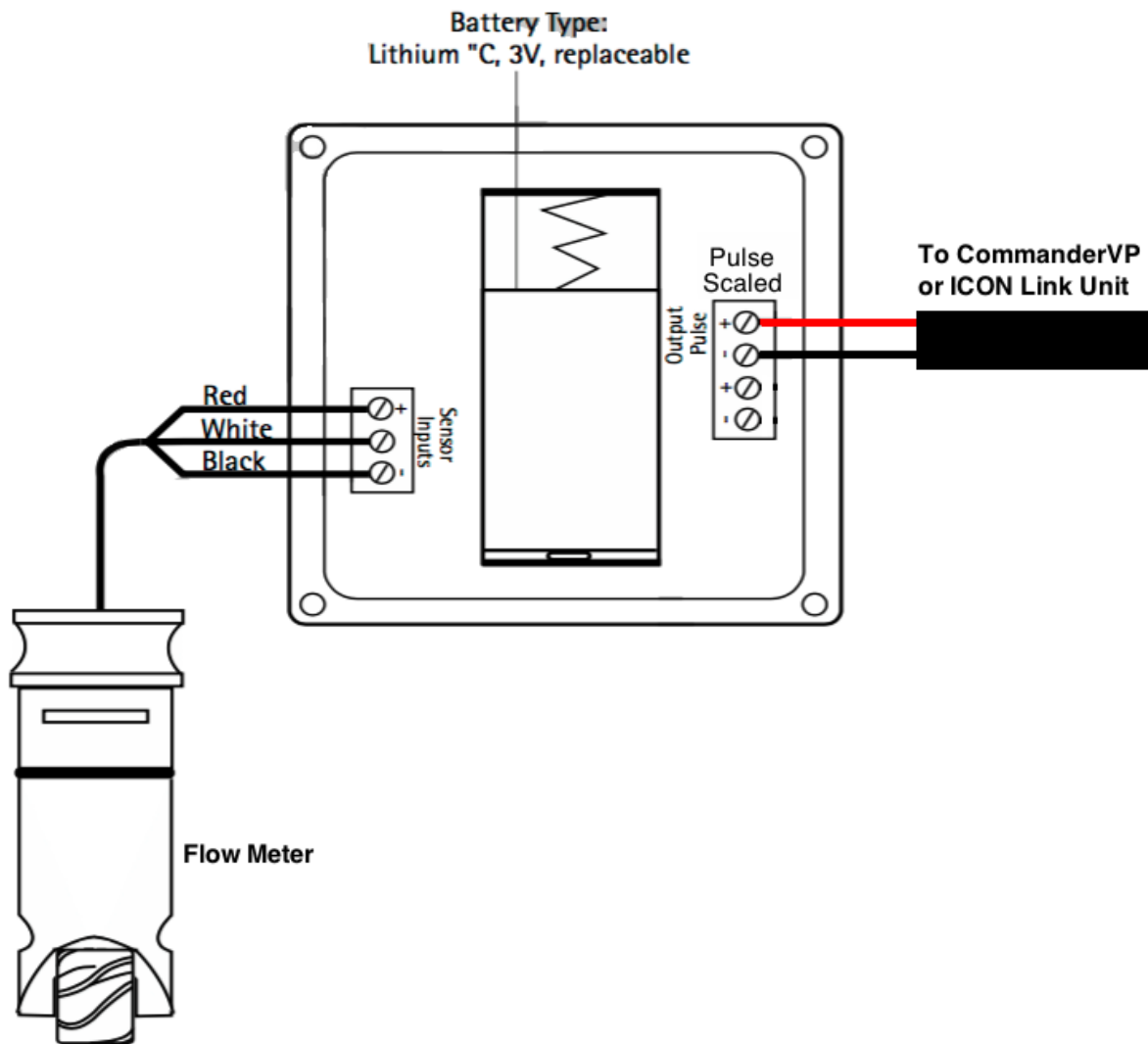

1. Install a Black Wire into the FT415 Flow Meter into the terminal marked **Pulse Scaled Output -** as shown in the picture above.
2. Install a Red Wire into the FT415 Flow Meter into the terminal marked **Pulse Scaled Output +** as shown in the picture above.

## CommanderVP Connections for the Seametrics FT415 Flow Meter

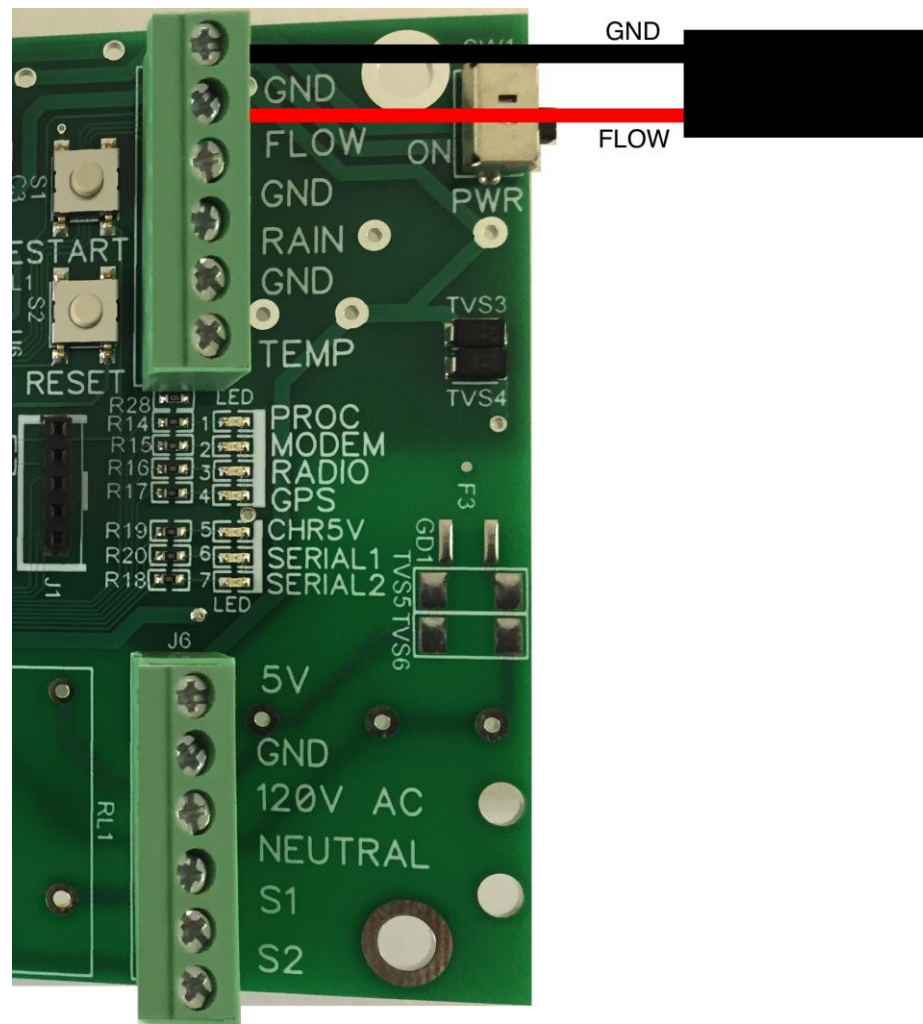

1. Install the Black Wire from the FT415 Flow Meter into any terminal marked **GND** as shown in the picture above.
2. Install the Red Wire from the FT415 Flow Meter into the terminal marked **FLOW** as shown in the picture above.
3. CommanderVP Unit Configuration: Click on the Config tab, and in the Digital 1 Options section, select TigerMag from the flow meter list, and enter either 10 or 100 gallons per pulse (depending on how you set the flow meter settings above).

# Wire Connections for the Sparling Tiger Mag Flow Meter

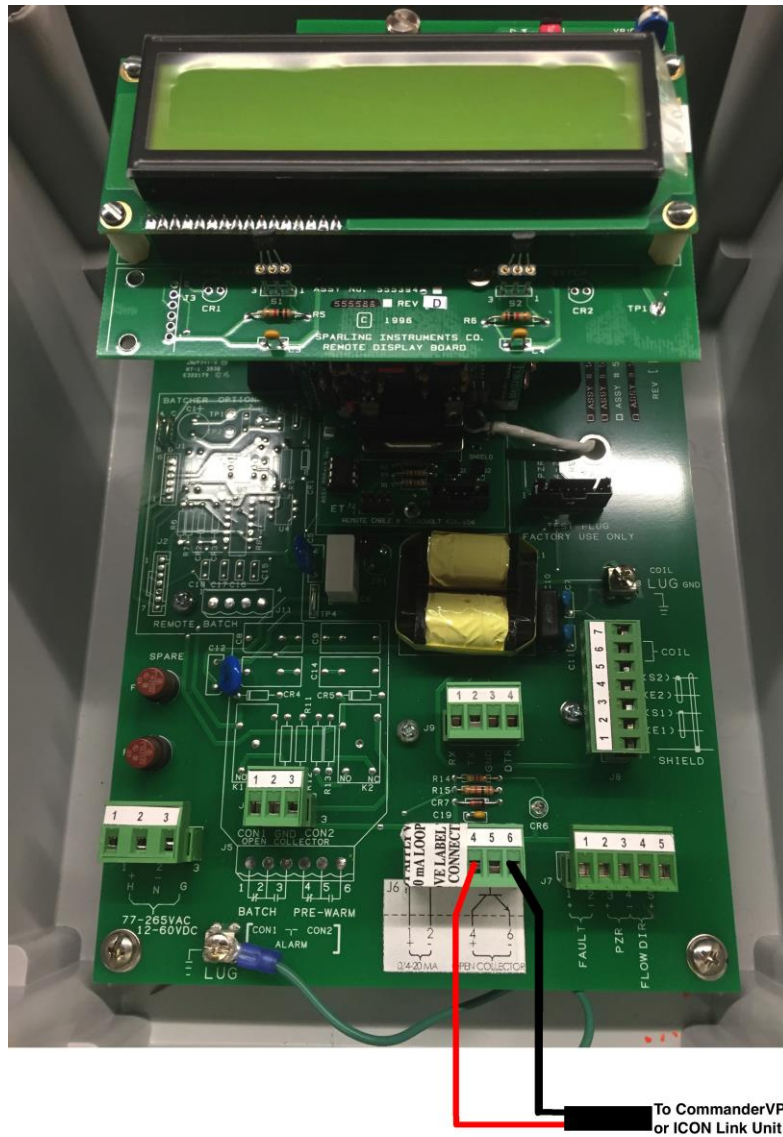

**The Tiger Mag Flow Meter must be an OPEN COLLECTOR output – contact Sparling for more info.**

1. Install a Black Wire into the Tiger Mag Flow Meter into the terminal marked **Open Collector** - as shown in the picture above.
2. Install a Red Wire into the Tiger Mag Flow Meter into the terminal marked **Open Collector +** as shown in the picture above.



## CommanderVP Connections for the Sparling Tiger Mag Flow Meter

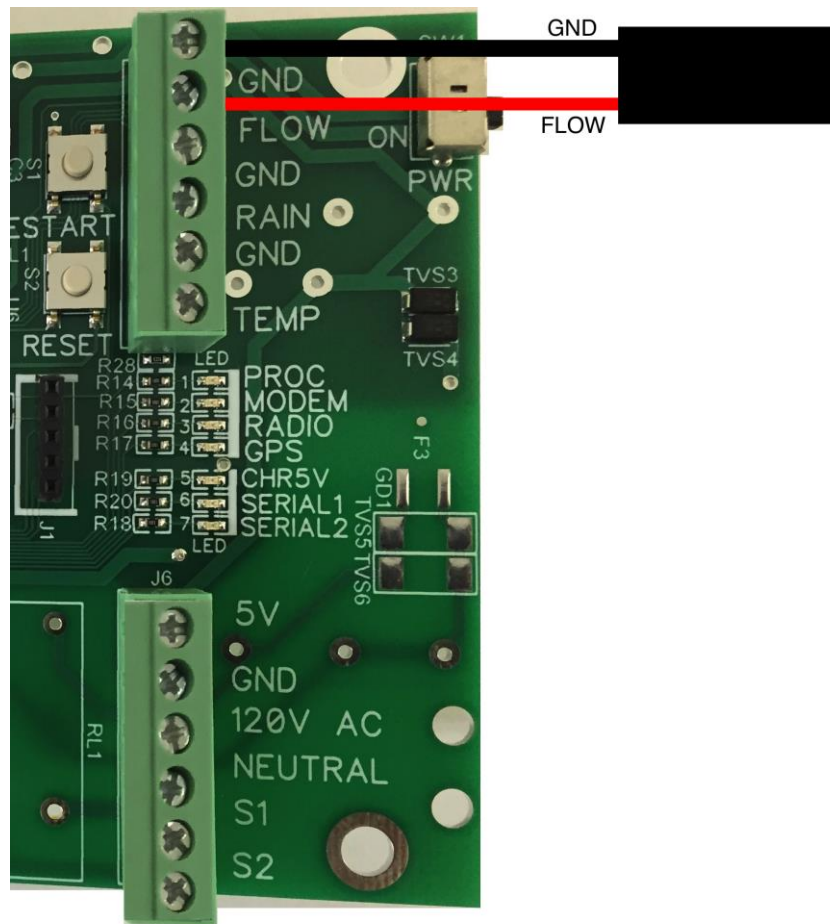

1. Install the Black Wire from the Tiger Mag Flow Meter into any terminal marked **GND** as shown in the picture above.
2. Install the Red Wire from the Tiger Mag Flow Meter into the terminal marked **FLOW** as shown in the picture above.
3. See the next page for flow meter menu settings.

# Sparling Tiger Mag Flow Meter Menu Settings

Tiger Mag menu:

Rescale Rate menu:

Rate units = GPM

Conversion Factor 1=1.0000000 GPM

Rescale Total menu:

Count direction = FWD Only

TOT Units = GAL

Set Registration = 10 or 100 (depends on how much total flow GPM you are going to have, low amounts of flow use 10, high amounts of flow (higher than 600-700 gpm) use 100 – this equals how many pulses per minute this flow meter will send, and you will enter this same number (10 or 100) on the CommanderVP Config page in the Gallons Per Pulse section.

Set Outputs menu:

Empty Pipe Detection (EPD) = 5 – this is just a starting point, these meters default to EPD=0 and thus will count some flow when the pipe is empty, so need to start with 5 and adjust from there to see what works best, refer to the Tiger Mag manual for more information.

CommanderVP Unit Configuration: Click on the Config tab, and in the Digital 1 Options section, select TigerMag from the flow meter list, and enter either 10 or 100 gallons per pulse (depeding on how you set the flow meter settings above.

# Wire Connections for the Sparling FT194 Flow Meter

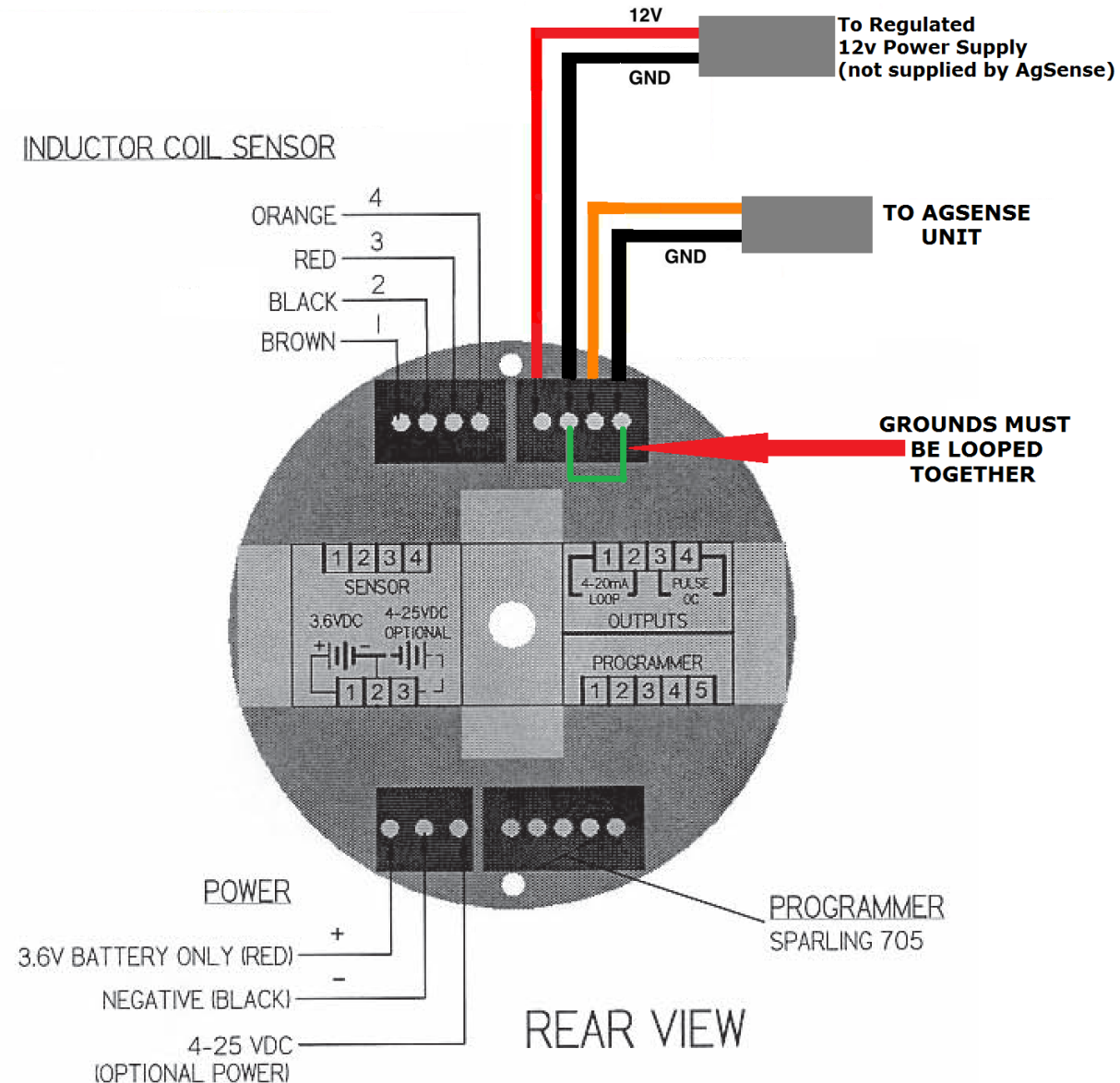

1. Install a Black Wire into the Flow Meter in the terminal marked **#4 Pulse OC** - as shown in the picture above.
2. Install an Orange Wire into the Flow Meter in the terminal marked **#3 Pulse OC** as shown in the picture above.
3. Flow meter also requires power to operate. Install wires from a 12v DC regulated power supply into terminals #1 and #2 (4-20mA Loop) and make sure the Ground wire is also looped over to terminal #4.

## CommanderVP Connections for the Sparling FT194 Flow Meter

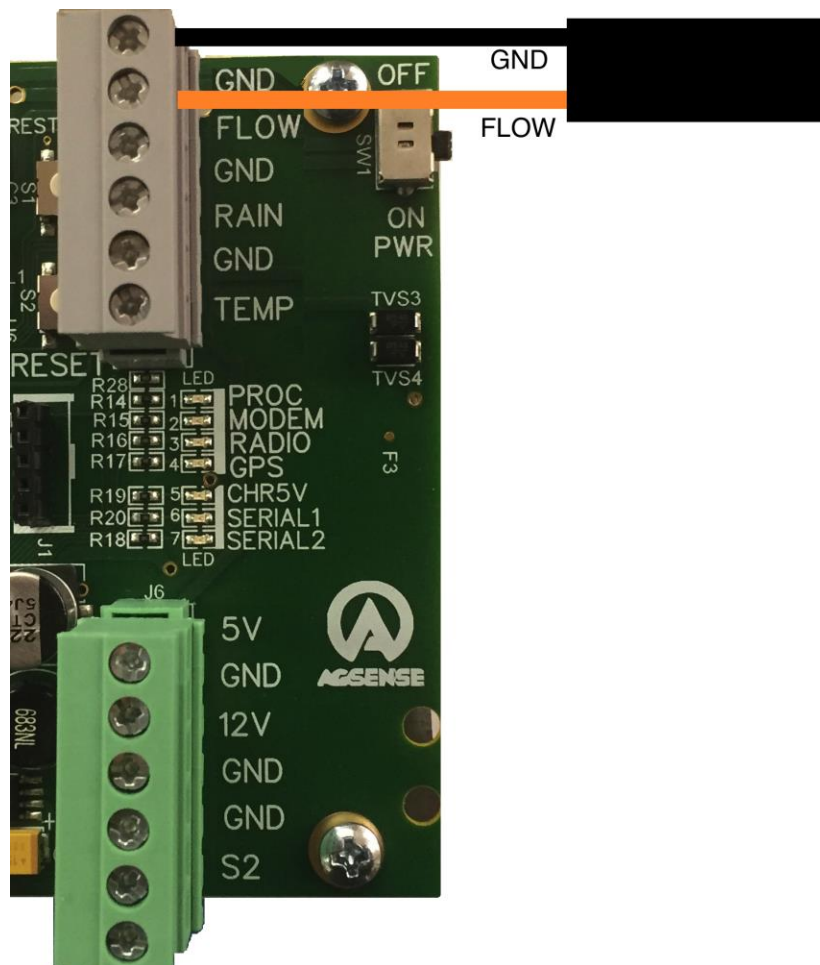

4. Install the Black Wire from the Flow Meter into any terminal marked **GND** as shown in the picture above.
5. Install the Orange Wire from the Flow Meter into the terminal marked **FLOW** as shown in the picture above.

## Generic Flow Meter Wiring

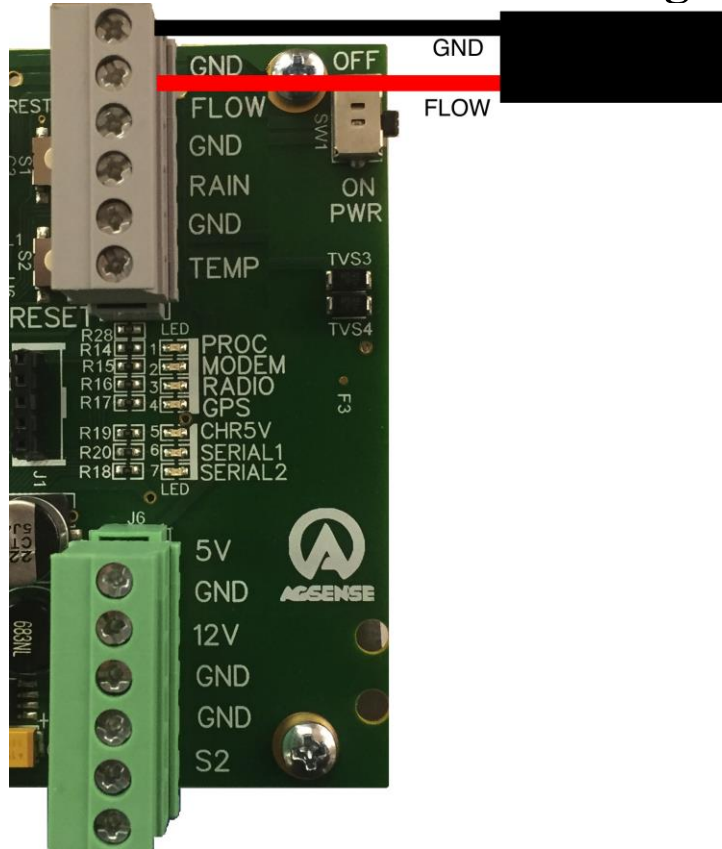

Any flow meter with pulse output can be connected to the Aqua Trac Unit.

### Requirements:

1. Flow meter must have an isolated (not self-powered) pulse output that is either a switch/relay closure style, or an electronic open collector type pulse output. The important part is that the flowmeter needs to connect the two wires shown above together for each pulse.
2. Each Pulse momentarily connects the two wires together to indicate a pulse, then disconnects them again. The Pulse must be longer than 2ms each.
3. Flow meter typically is setup so each pulse is either 10 or 100 gallons per pulse. (depending on flow meter size) For example, systems that typically flow less than 300GPM, use 10 gallons per pulse - and systems that typically flow more than 300GPM, use 100 gallons per pulse.

Power Requirements for these units:

**DC Powered Unit 7-40V DC:**

At 12v DC: 1.0A MAX

0.1A - 0.5A during normal operation

**Warranty Information:**

All warranty service provided by the AgSense service center, or an authorized technician.

**Warranty repairs require a Return Merchandise Authorization Number (RMA);  
Have your dealer contact AgSense to obtain this RMA number.**

For the Period of :	AgSense will:
<b>60 Days</b>	Money back Guarantee if not satisfied with product.
<b>2 Year</b>	Repair on any unit that fails due to defect in materials or workmanship. AgSense labor and parts would be provided free of charge during the warranty period. (This does not include dealer labor.)

**What is not covered:**

- Service trips to your home to teach you how to use the product.
- Improper installation, delivery or maintenance. If you have an installation problem contact your dealer or installer.
- Failure of product resulting from modification to product or due to unreasonable failure to provide reasonable and necessary maintenance.
- Labor necessary to move device from one location to another.
- Improper installation of battery.
- Failure due to corrosion or water damage.
  - Units installed in direct contact with sprinklers require a tower box or other watertight protection.
- Damage to the product caused by improper power supply voltage, accident, fire, floods or acts of God.
- Damage caused after delivery.

**Exclusion of implied warranties – Your sole and exclusive remedy is product repair as provided in this Limited Warranty. Any implied warranties, including the implied warranties of merchantability or fitness for a particular purpose, are limited to one year or the shortest period allowed by law.**

This warranty is extended to the original purchaser and any succeeding owner for the products purchased for use within the USA.

Some states do not allow the exclusion or limitation of incidental or consequential damages. This warranty gives you specific legal rights, and you may also have the other rights which vary from state to state. To know what your legal rights are, consult your local or state consumer affairs office or your state's Attorney General.

**DISCLAIMER:** The use of Field Commander/Crop Link shall not be utilized by customer as a substitute for the Customer's personal observation of the manner in which Customer's irrigation equipment is functioning. AgSense specifically advises Customer that this product is designed to enhance Customer's ability to control existing irrigation equipment and to provide the Customer with additional information about existing irrigation equipment. Field Commander/Crop Link relies upon GPS, Satellite and Internet technology which not always functions properly, accordingly, AgSense disclaims any and all responsibility for the reliability of this technology. Customer acknowledges that AgSense does not have the ability to control the reliability of GPS, Satellite and Internet Technology. AgSense specifically disclaims any and all liability for Customer's failure to personally determine whether or not the irrigation equipment that belongs to Customer is functioning properly. AgSense, its agents, members or officers will not be liable for Customer's loss of profits, business interruption, or any other type of consequential damages arising because of the failure to Customer's equipment, GPS, Satellite or Internet to function properly.

**CUSTOMER'S RESPONSIBILITIES:** Customer agrees to keep the irrigation equipment upon which Field Commander/Crop Link is installed in good repair and maintenance. Customer acknowledges the importance of and agrees to keep all safety devices which came with Customer's irrigation equipment in working order. Customer agrees to keep an end field stop and barricades in place to prevent damage to the irrigation equipment in the event that Field Commander/Crop Link malfunctions. Customer agrees that Field Commander/Crop Link cannot solely replace the personal monitoring of the operation of irrigation equipment.

**REMEDY:** Customer acknowledges that Field Commander/Crop Link's sole obligation and Customer's exclusive remedy in the event of any material and continuing nonconformity, defect, or error in the information service shall be to take reasonable corrective actions upon discovery of the problem.

AgSense, LLC  
259 Dakota Ave S  
PO Box 53  
Huron, SD 57350  
605-352-8350  
[www.AgSense.net](http://www.AgSense.net)